

User Guide For Surface Supplied MOD-1



Document P/N 100-815

Kirby Morgan Dive Systems, Inc.

1430 Jason Way

Santa Maria, CA 93455, USA

Telephone (805) 928-7772

FAX (805) 928-0342

E-Mail: kmdsi@kirbymorgan.com

Web Site: www.kirbymorgan.com

Kirby Morgan, SuperLite, BandMask, Band Mask, KMB, KMB-Band Mask, DSI, Diving Systems International, EXO, REX, SuperFlow and DECA are all registered trademarks of Kirby Morgan Dive Systems, Inc. Use of these terms to describe products that are not manufactured by KMDSI is illegal.

The two dimensional images (such as photographs and illustrations) of our products are © copyrighted and trademarks of Kirby Morgan Dive Systems, Inc. The three dimensional forms of our products are trademark, trade design and trade dress protected.

© MMXXII Kirby Morgan Dive Systems, Inc. All rights reserved. This user guide is made available for the express use of owner of this Kirby Morgan product. No part of this user guide may be reproduced, stored in any retrieval system, or transmitted, or used in any form or by any means, whether graphic, electronic, mechanical, photocopy, or otherwise by technology known or unknown, without the prior written permission of Kirby Morgan Dive Systems, Inc.

WARRANTY



USE ONLY KIRBY MORGAN® GENUINE PARTS

Kirby Morgan Dive Systems Inc., (KMDSI) warrants every new helmet, BandMask®, Full Face Mask, SCUBA regulator or air control system (KMACS 5) (each, a Product) to be free from defects in workmanship for a period of three hundred sixty five (365) days from the date of purchase from a KMDSI authorized dealer. This warranty covers all metal, fiberglass, and plastic parts, but does NOT cover rubber parts, communications components, head cushions, chin cushions, or foam spacers.

Any defect of the product in workmanship or material covered by this warranty discovered within three hundred sixty five (365) days from the date of purchase must be promptly communicated in writing to the nearest authorized KMDSI dealer or (if no such dealer in the buyer's country) contact KMDSI directly at (805) 928-7772. No Product returns will be accepted by KMDSI without a returned merchandise authorization (RMA) number from KMDSI. Upon receipt of the RMA from KMDSI, the buyer should return the defective Product or part, freight prepaid, to an authorized KMDSI dealer or the KMDSI plant, as directed by the RMA department. KMDSI will repair or replace the Product at no charge, within a reasonable time, as it deems necessary.

THIS WARRANTY IS NULL AND VOID IF:

- 1) The Product is not registered with KMDSI within ten (10) days of purchase, or
- 2) The Product has not been properly serviced and/or maintained by KMDSI factory trained/approved personnel, according to factory recommended procedures provided in the manual, along with the KMDSI Appendices Checklists, and/or Product updates have not been performed as recommended by KMDSI, or
- 3) Unauthorized attachments or modifications have been made to the Product, or
- 4) The Product has been used for purposes other than those for which it was designed, or otherwise has been abused, misused, or subjected to unusual conditions, or the Product's intended service has been exceeded.

EXCEPT AS SPECIFICALLY PROVIDED HEREIN, THERE ARE NO OTHER WARRANTIES, EXPRESS OR IMPLIED, INCLUDING, BUT NOT LIMITED TO, ANY IMPLIED WARRANTIES FOR MERCHANTABILITY OR FITNESS FOR A PARTICULAR PURPOSE. THE HELMETS, BANDMASKS AND AIR CONTROL SYSTEMS COVERED BY THIS WARRANTY ARE MARKETED AND SOLD BY KMDSI SOLELY FOR COMMERCIAL OR INDUSTRIAL USE AND ARE NOT A CONSUMER PRODUCT INTENDED FOR PERSONAL, FAMILY, OR HOUSEHOLD USE.

In purchasing any Product subject to this warranty, the buyer agrees that its sole and exclusive remedy and KMDSI's entire obligation in contract, tort, or otherwise under this contract will be repair or replacement at KMDSI's option of the Product or any parts which KMDSI determines during the applicable warranty period are defective in workmanship or material covered by this warranty. All exchanged parts are the property of KMDSI. The buyer's exclusive remedy and KMDSI's entire liability in contract, tort, or otherwise is the payment by KMDSI of the buyer's actual damages up to but not to exceed the amount paid by the buyer for the Product.

In no event shall KMDSI be liable to the buyer for indirect, special, incidental or consequential damages (including, but not limited to, damages for lost profits, lost sales, loss of business opportunity, or for injury to persons or property arising out of the use of the Products). Any claim or action for breach of warranty must be commenced within one year following delivery of the Product to the buyer.

Buyer acknowledges that this warranty is the sole and exclusive warranty of the Product and that it supersedes any and all oral or written representations and undertakings between KMDSI, its dealers, and the buyer relating to the Products. This warranty allocates the risks of product failure between KMDSI and the buyer, which allocation is recognized by both parties and is reflected in the price of the goods. The buyer acknowledges that they have read this agreement, understand it, and are bound by its terms.

IMPORTANT: Please register your purchase online at www.kirbymorgan.com/support/product-registration-form. If you have a problem with the online registration, please contact your Kirby Morgan dealer, or Kirby Morgan directly by calling (805) 928-7772, or email sales@kirbymorgan.com.

Kirby Morgan® thanks you for your purchase.

Table Of Contents

2	Warranty
6	Definitions of Signal Words and Terms Used in this Guide
7	Terms used in this Guide
7	Introduction
8	Serial Number Location
9	Communications
9	Hood Assembly
9	Regulator
10	Side Block
10	Mask
10	Vent Holes
11	Components of the Surface Supplied MOD-1
12	CE Marking
13	Notified Body
13	Product Specification
13	Surface Supplied MOD-1 Transport and Storage
14	Minimum Equipment for Surface Supplied Diving
14	Preparing the Surface Supplied Pod for Diving
14	Gas Supply Hoses
15	Main Supply
16	Emergency Gas System (EGS)
16	Installation/Removal of MOD-1 Hood
17	Installation/Removal of Mask Strap
18	Strap Keepers
18	Cleaning the Face Port and Interior Surfaces
18	Communications with the Surface Supplied Pod
18	Communications Check

19 Attaching the Umbilical to the Harness

19 One Way Valve Check

20 Oral One Way Valve Check

20 Low Pressure One Way Valve Check

21 Communications

21 Communications Pin Identification

21 Removal/Installation of a Microphone Assembly into the Surface Supplied Pod

22 Removal

23 Installation

25 Microphone Element Removal

25 Pre-Dive

25 Diving Procedures

26 Donning the Mask

28 Equalizing

29 Water Entry

29 Regulator Adjustment Knob

29 Supply Pressure

30 Lens De-Fogging

30 Emergency Procedures

30 Mask Clearing and Dewatering

30 Main Supply Gas Flow Stops

31 Demand Regulator Free Flow

31 Removing the Mask

31 Post Dive Procedures/Checklist

32 Cleaning Procedures

34 Germicidal Solutions Manufacturers

34 Conservation and Storage

34 Scheduled Maintenance

35 Disassembly Guidelines

35 Adjustments and Minor Repairs

35 Supply Pressures

36 Accessories/Spares

36 Prescription Lenses

36 Jumper Hose P/N 855-010

37 Over-Pressure Relief Valve P/N 200-017

37 KMDSI Mask Bag P/N 800-905

37 One-Way Valve Assembly P/N 505-060

37 Adapter P/N 850-155

38 MOD-1 Hood Assembly w/ Bib L/XL, 7 mm P/N 805-125

38 Hood Mount Stud Block P/N 850-095

Definitions of Signal Words and Terms Used in this Guide

The original language of the Kirby Morgan Manuals is English. Translation into other languages will be provided upon request. KMDSI may charge a fee for these services.

Throughout this user guide we will use certain words to call your attention to conditions, practices or techniques that may directly affect your safety. Pay particular attention to information introduced by the following signal words:

DANGER

This word indicates an imminently hazardous situation, which if not avoided, could result in death or serious injury.

WARNING

This word indicates a potentially hazardous situation, which, if not avoided, could result in death or serious injury.

CAUTION

This word indicates a potentially hazardous situation, which if not avoided, may result in minor or moderate injury. It may also be used to alert against unsafe practices.

NOTICE

This word is used to address practices not related to personal injury.

This user guide contains important safety information and should always be available to those personnel operating this equipment. Read, understand, and retain all instructions before operating this equipment to prevent injury or equipment damage.

If you sell or loan this equipment to another person, be sure that this user guide accompanies the gear when you transfer possession to them.

Terms used in this Guide

IAW: In Accordance With

EGS: Emergency Gas System

Nose Dam: Located on the inside of the mask, is an extended barrier that separates the upper (visual) portion of the mask from the lower (oral) part of the mask.

PPE: Personal Protective Equipment

Introduction



NOTE

Further information pertaining to the Surface Supplied MOD-1 can be found in the Description and Operational Specifications and General Information KMDSI Products modules, along with the Kirby Morgan website: www.kirbymorgan.com.

The Surface Supplied Pod is the latest addition to our Modular Full Face Mask product line.

The new Surface Supplied Pod is constructed of specialty polymers/elastomers and machined components of titanium and high grade stainless steels. The oral cavity has extremely low volume and greatly reduces residual levels of CO₂. The volume also works well for communications. This Pod is designed to be operated only in the surface supplied diving configuration.



It is very important when making adjustments to the Pod that the technician/operator has a way to **add extra light** to the area of the Pod they are working on. Our best recommendation is the use of a head lamp.

Serial Number Location

The M-48 MOD-1 serial number is printed on the left side of the upper leading edge of the mask frame along with the part number for the mask and the CE mark on the right hand side.



The serial number is located on the bridge of the Surface Supplied Pod Assembly.

Communications

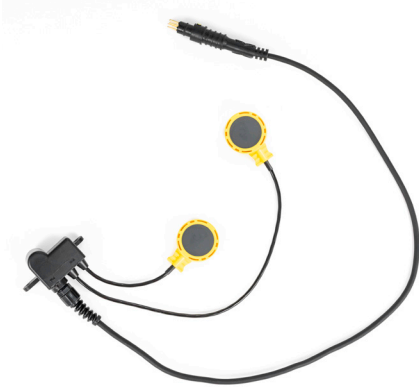

The communications are modular, with earphone/microphone elements routed to an externally mounted communication module which is easily removed and replaced if needed. Current model has the microphone easily removable as a complete plug-in microphone assembly, or the microphone element can be separated by itself. Future improvements will be independent attachments for the earphone elements as well.

Hood Assembly

Includes earphone pockets. The attached hood is easily removed for replacement.

Regulator

The main tube assembly is a slight variation from the main tube assembly of the balanced SCUBA regulator. All parts are interchangeable except the balance spacer, P/N 850-170 and adjustable nipple P/N 550-163.

The regulator assembly has been designed and manufactured with pride, according to Kirby Morgan's world renowned exacting standards for quality and performance. The Kirby Morgan Balanced SCUBA Regulator is a high performance regulator which was designed for the professional diver. The second stage is a modified version of the same regulator used on the Kirby Morgan 97 helmet and stand alone 455 balanced regulator. Many of the parts used in this regulator are identical to those used on the KM 97 helmet and 455 balanced regulator. This is helpful to dealers in stocking parts for service and repair.

Provided it has been purchased new from an Authorized KMDSI Dealer, your regulator assembly is covered by KMDSI's Limited Warranty. Be sure to read and fill out the warranty card completely and return the bottom portion within ten (10) days of purchase. Also save your sales receipt. A copy of your receipt must be presented whenever obtaining warranty service.

Perhaps more than any other piece of diving equipment, your regulator's function and performance relies greatly on the care and maintenance it will receive, in addition to regularly scheduled dealer service. Before you dive with your new Kirby Morgan regulator, it is important to read this guide in its entirety; to become familiar with its features, as well as the correct procedures for setup, pre-dive inspection, and post-dive maintenance.

Side Block

The linking component to the regulator, from the side block, is made out of titanium for strength and to eliminate corrosion, and excess weight. The body and additional metal components are made from 316L stainless steel. The design of the control valves is extremely simple and easy to maintain.

Mask

We do not recommend that this product be operated in contaminated water. No matter what the Pod configuration used this diving system is **not an acceptable form of protection against biological contaminants.**

Vent Holes

The mask skirt has two vent holes located in each eye cavity of the mask. Using the defogger control knob and inhaling through the nose, defogs the lenses with ease.



Components of the Surface Supplied MOD-1

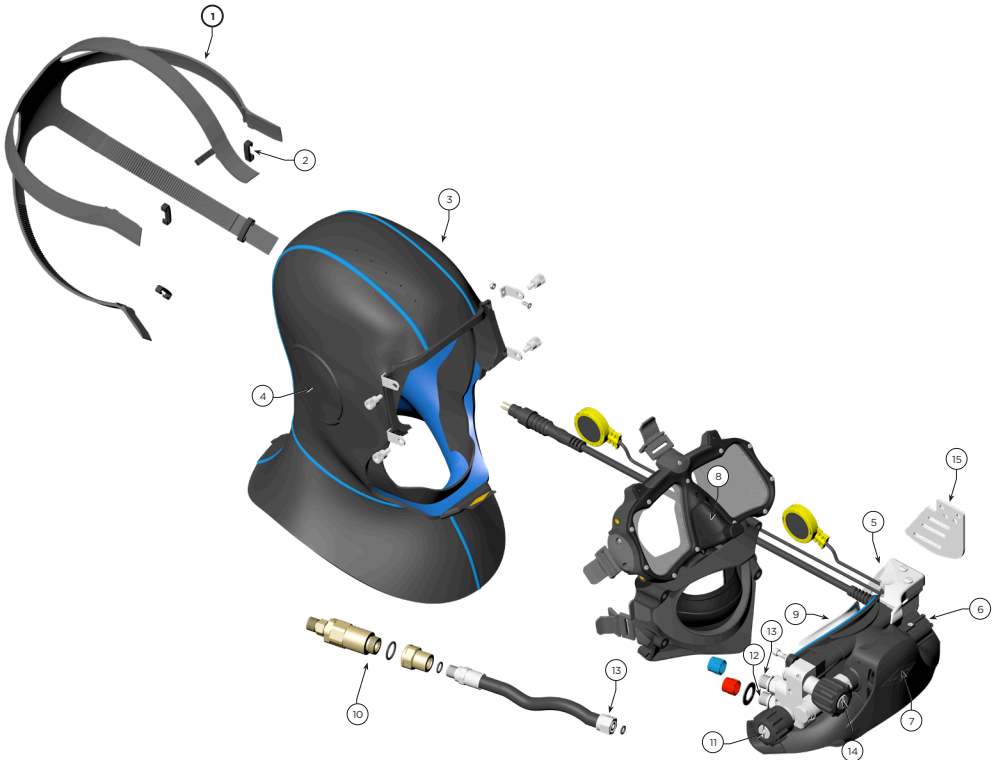

Loc #	Description
1	Mask Strap
2	Strap Keeper
3	Hood
4	Ear Pockets
5	Port Weight
6	Regulator Adjustment Knob
7	Purge Zone
8	Nose Pocket
9	Oral Cup
10	One way valve
11	EGS valve
12	EGS supply inlet
13	Main gas supply inlet
14	De-Fog Control
15	Guard

CE Marking

The Surface Supplied MOD-1 has been tested and conforms to the performance requirements as set forth in Annex II of Regulation (EU) 2016/425 and, as far as applicable, the EN 15333-1 (Class C). It is fully CE marked with Surface Supplied POD (P/N 805-225) and the Surface Supplied MOD-1 P/N 500-800.

This mask is intended for diving to maximum depth of 165 fsw/50 msw and is not intended for the SCUBA diving configuration. This number represents the CE limit for air diving, not the product's depth limit.
Category of PPE: III

⚠ WARNING

The Surface Supplied MOD-1 has been tested with air and CE certificated for use with air up to 50 meters. Compressed air must be compliant with the EN 12021. All the tables reporting the technical data and the pressure of use are relative to compressed air.

On the underside of Pod Housing Sub assembly the CE mark is printed. On the Chamber Cover the data reported is the following:

1. The name and address of the manufacturer and year of manufacture
2. CE marking **CE**
3. The Model (Surface Supplied Pod)
4. Harmonized reference standard EN15333-1
5. Number of notified body



Notified Body

The Notified Body is:

Eurofins Product Testing Italy
Via Courgnè, 21 - 10156 Torino
ITALY
Identification Number: 0477

Product Specification

805-225 Surface Supplied Pod: 1.95 lbs. (0.88 Kg)

500-800 Surface Supplied MOD-1: 3.8 lbs. (1.71 Kg)

Surface Supplied MOD-1 Transport and Storage

Weight of the package: 6.4 lbs. (2.9 Kg)

Package dimension 12 × 12 × 12 inches



Minimum Equipment for Surface Supplied Diving

The minimum equipment for surface supplied diving with this Pod includes the following:

- Topside gas supply (either low pressure compressor or high pressure cylinders)
- Umbilical with breathing gas supply hose, strength member, communications wire, and pneumo fathometer hose
- One Way Valve (Non-Return)
- Communications box
- Diver worn bail-out bottle with diving harness.
- Bail-out 1st stage regulator with overpressure relief valve and Submersible pressure gauge.
- If the diver's main gas supply fails, the diver must have another source of gas that will enable them to return to the dive station or to a point where a normal gas supply can be reestablished. For this reason, **an emergency gas supply bailout cylinder must be used on all dives.**

Preparing the Surface Supplied Pod for Diving

Gas Supply Hoses

Both the main supply (upper) and EGS supply (lower) inlet fittings, found at the attachment point of the side block, are standard SCUBA threads— $\frac{9}{16}$ inch-18 male threads. The supply hoses, from the emergency gas system, should be of sufficient length to allow full movement of the head when connected to the Pod. ALWAYS connect the main umbilical fitting to the jumper hose and check valve assembly that was supplied with the mask.

This mask was specifically designed for divers comfort, mobility and safety by eliminating typical loads that are used with heavier types of diving equipment supply umbilical attachment.

⚠ WARNING

Never connect the main gas supply hose from the diving control station to the Emergency Gas valve assembly (EGS) on the Pod. The EGS fitting is the lower fitting of the two that are on the side block. Failure to incorporate a check valve into the main supply line can result in serious personal injury or death.

Main Supply



The inlet fitting for the main gas supply is the upper or top inlet fitting on the side block. A “jumper” SCUBA hose must always be used to connect the main gas supply through a one way valve and to the side block on the Pod. A big bore “jumper” hose comes with the pod which includes an adapter to secure the one way valve directly to the umbilical gas supply hose. This length is a “suggested” length.

The importance is to NEVER secure the main gas supply, umbilical hose end, directly to the pod. An additional jumper hose with one way valve (provided) or manifold block with one way valve must always be used.



Emergency Gas System (EGS)

The lower/bottom inlet fitting on the side block is for the EGS gas supply. It is recommended to use a set of good quality quick disconnecting fittings with locking sleeves to connect the first stage regulator to a shorter hose that is secured to the emergency valve inlet located on the side block.

⚠ WARNING

Never connect the main gas supply hose from the diving control station directly to the side block. If this is done there is no one way valve protection for the diver in the event of damage to the umbilical or related equipment. The diver could be exposed to a serious “squeeze”. This can result in serious personal injury or death.

If the diver's main gas supply fails, the diver must have another source of gas that will enable them to return to the dive station or to a point where a normal gas supply can be reestablished. For this reason, an emergency gas supply (bailout) cylinder must be used on all dives. The bailout cylinder is worn on the back using a combination backpack and lifting harness.

⚠ WARNING

Do not dive without a diver worn Emergency Gas System. If the main gas supply is lost, you will have nothing to breath and may drown.

Installation/Removal of MOD-1 Hood

The hood can be installed with the mask strap on the mask.



1. Bring the hood assembly to the mask.



NOTE

This usually requires forming the neoprene flap at the front of the hood to the mask face seal area. This will make aligning and installing the retaining screws easier.

2. Align tabs to mask and insert screws.



3. Ensure that, on both sides of the mask, the neoprene material tucks inside of the leading edge where the lens body and jaw frame meet.



4. Stretch the pull tab away from the mask and over the apex of the lower jaw frame. Use the nylon pocket to capture the apex of the jaw frame.



Installation/Removal of Mask Strap

The strap keepers **MUST** be removed to install or remove the mask strap. We recommend replacing the strap keeper back onto the strap groove once it has been pulled through the buckle assembly. This will lower the

chance of losing the strap keeper and ensure correct orientation into the strap groove.

The standard mask strap is a five-point semi-stretch head harnesses, P/N 810-007. The mask strap has five straps branching out from a junction at the bottom OUTER surface of the strap, where “Kirby Morgan” and the diamond logo can be seen. Each strap leg has many buckle adjustment “teeth”. Keep in mind that these teeth should be against the divers head before being threaded into the buckle assembly and the smooth surface should face outward once it has gone through the buckle assembly.

Strap Keepers

Each of the five straps has a strap keeper. The strap keeper is secured in a groove found at the end of the strap before the tapered end. The strap keeper should be installed on the strap, with the small gap in the keeper, oriented with the smooth side of the strap. The mask strap cannot be removed from the mask without removing the Strap Keeper. Installing the strap keeper should be installed after the strap has been threaded through the buckle assembly.

Cleaning the Face Port and Interior Surfaces

The mask frame and Pod components are made of high impact plastic. The flexible face seal and Pod skirts are molded of high-grade injection molded liquid silicone. The lenses are made of tempered glass. Ensure that the viewing lenses are clear and clean. Fogging can be eliminated or reduced by thoroughly cleaning the interior of the lens and applying a good quality anti-fog solution. Follow the manufacturer’s recommendations for use.

Communications with the Surface Supplied Pod

The microphone is connected to the module through a connector body and uses a wire jumper assembly which allows rapid removal and replacement without having to remove the communications assembly from the Pod. The microphone element is captured by a shroud that is designed to refine the diver’s voice transmission. It is easily removable, but not necessary when completing a post dive sanitization and inspection.

Communications Check

Check the communications system for proper operation. Put the mask on without tightening the mask straps and talk normally into the mask. A slow

count up to five and back to one from the diver to the topside operator and topside operator to diver should be the bare minimum test performed to ensure microphone and speaker levels are at a good starting point.

Attaching the Umbilical to the Harness

Most commercial divers wear a harness (separate from the weight belt) that is used for several purposes. The harness is fitted with large metal rings (usually brass or stainless steel). The umbilical is hooked into one of these rings to keep any strain off the mask. In addition, the rings on the harness are used to hang tools and other equipment. Usually, the harness is also designed to provide a means of lifting an unconscious diver from the water. A harness is the best method of securing the emergency breathing gas to the diver.

WARNING

Never dive without attaching the umbilical to a proper harness assembly that meets industry standards and can be used to safely lift an unconscious diver out of the water. The lift point must be done in a way so there is no pull on the diver's mask. Never allow the umbilical to pull on the mask directly or the diver could suffer a neck injury.

One Way Valve Check

The one way valve must be tested daily, before the commencement of diving operations OR after extended periods of the mask/check valve being stored.

1. There are three methods for testing the one way valve.
2. Orally
3. Using regulated low pressure.
4. Using a hand operated Vacuum Pump

WARNING

The one way valve must be tested daily, prior to commencement of diving operations. Failure of the one way valve could cause serious injury or death.

The free flow valve (de-fog control) must be open when performing the test.

Oral One Way Valve Check

1. Test the one way valve for proper operation by blowing and sucking (cycling) on the main gas supply inlet. No gas should be drawn through the one way valve. If you are able to suck any air through the one way valve, it is not working properly and should not be used.

Low Pressure One Way Valve Check

1. Close the emergency and defogger control knobs and screw in the adjustment knob on the regulator all the way.
2. Attach a regulated gas supply (normally using the EGS system), adjusted to between 135-150 psig (9.3-10.3 bar), to the emergency valve.
3. Open the emergency supply valve all the way and then slowly open the gas supply.
4. Check for gas exiting from the one way valve. There should be no gas exiting the umbilical adaptor. If any gas exits through the one way valve it is not working properly and should not be used.

Communications

Communications Pin Identification

Your Surface Supplied MOD-1 has been wired for a 4-wire (Round Robin) type communication system. A 4-pin waterproof connector is used and is wired as shown. The view shown looks at the connector's pins, and pin 1 is the larger one. This 4-pin configuration is the factory KMDSI configuration and is the same used in all KMDSI helmets and BandMasks.

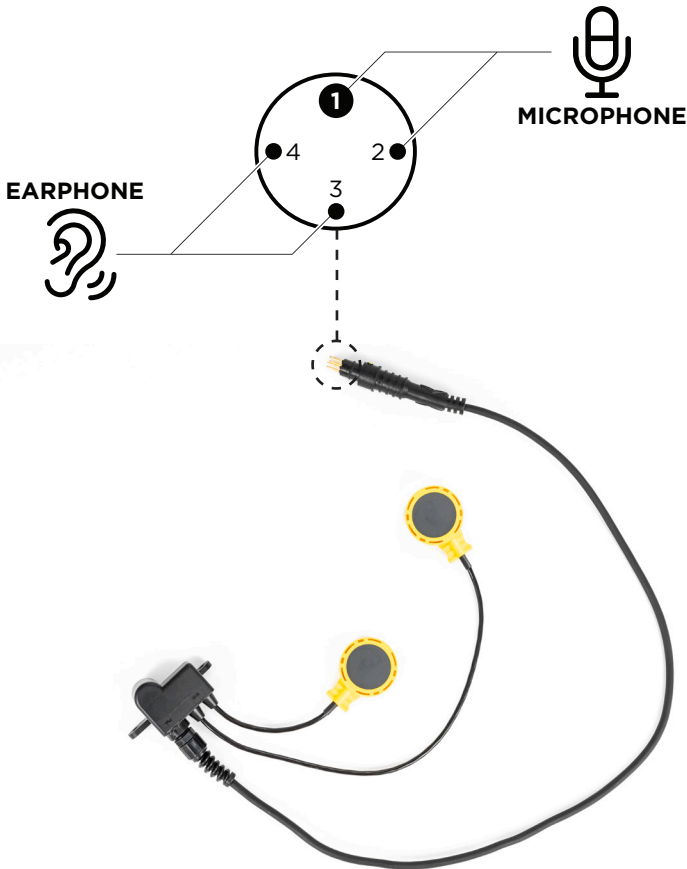

Removal/Installation of a Microphone Assembly into the Surface Supplied Pod

The microphone element is captured by a shroud that is designed to refine the diver's voice transmission. It is easily removable, but not necessary when completing a post dive sanitization and inspection.

Removal

Tools suggested:

- Needle nose pliers



1. Fold back the corner of the oral cup to expose the two wires entering the connector body.



2. Use needle nose pliers to remove wire leads from connector body. Attention should be applied to gripping the crimp fittings and **NOT THE WIRES** when removing.

3. Lightly fold the oral cup to expose the outer face of the microphone and its shroud, push them through the oral cup towards the inside of the mask
4. Lift the corner edge of the Oral Cup out and away from mask.



5. Remove Microphone with shroud out of the Oral Cup.

Installation

Tools suggested:

- Needle nose pliers

The oral cup can remain installed into the Pod.



NOTE

Make sure the solid side of the microphone element is facing the diver's mouth. Make sure the microphone with shroud is positioned with the two small wings on the shroud, ready to push through the larger hole on the side of the oral cup. This will ensure the correct side of the microphone is facing the diver.



1. Thread the wires through the two small holes of the Oral Cup.



2. Fit the microphone with shroud into the receiving hole until the wings on the shroud pass through the oral cup large hole, and hold the microphone in place. Straighten the wires and pull out all the slack so microphone element is firmly secured into the microphone hole.



3. Fold in the corner of the Oral Cup and insert lead wires into Connector Body using the needle nose pliers.



Wires can be inserted to either hole of the connector body, as there is no polarity. After re-installation of the microphone, make sure the oral cup is properly connected to the exhaust valve body and properly seated into the pod interior.

4. Perform a communication check.

Microphone Element Removal

Tools Required:

- T6 Torx Driver

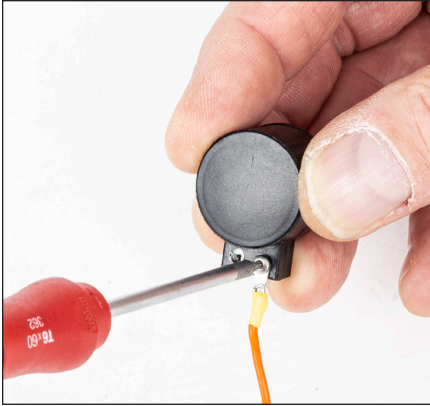

1. Use a T6 Torx driver to unscrew (counter clockwise) the two screws holding the microphone to the wire jumper.

2. Remove the Microphone



Removing the microphone from the Oral Cup is NOT required on a regular basis or mandatory for the Post-Dive.

NOTE

3. The microphone element is captured by a shroud that is designed to refine the diver's voice transmission. It is removable, but not necessary when completing a post dive sanitization and inspection.

Pre-Dive

Follow the M-48 and Surface Supplied Pod PRE-Dive Inspection Appendices as well as the Emergency Gas System Daily Set-Up and Functional Checklist for the Surface Supplied Pod.

Diving Procedures

Before dressing in for a dive, inspection of the entire diving system must be made to be sure it is in proper working order. This must be done well in advance of the dive so any problems can be fixed without delaying the dive.

Standard Pre Dive procedures and Dive Supervisory checklists should be followed in accordance with safe surface supplied diving operations. Unique to using this mask are as follows:

1. **One way valve MUST BE SECURED** in line with main supply if not installed.
2. **NEVER connect the main gas supply directly to the side block. A jumper hose MUST be used.**
3. Both main supply and EGS supply fittings are standard SCUBA threads- $\frac{3}{8}$ inch-18 male threads.
4. Side Block CONFIGURATION TOP Inlet is MAIN gas supply BOTTOM is EGS gas supply.
5. Normal operation the EGS control knob is in the FORWARD/OFF position.
6. Verify thin and smooth flap seal on the inside of hood is completely **outside of the mask's face seal**. The mask's face seal should be in contact the diver's face. *The hood's Outer Seal neoprene material should not be in contact against the divers face, but touching the outside wall of the mask skirt.*
7. It is recommended to use a defog solution.

Donning the Mask



Gas supplies should be hooked up and on.

NOTE

Before donning the mask, the mask straps should be extended to their full range.

1. Ensure the leading edge of the outer seal is clear of the mask skirt. The mask skirt should touch the diver's face first and the hood outer seal will surround the face where the mask skirt stops.

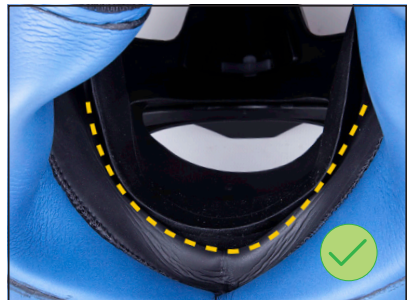



2. Unzip bib found on hood and hold the M-48 MOD-1 so that it is hanging from the Mask Strap and the five straps are completely loose.

3. Bring the mask up to your face and inside the hood. Zip the hood down and ensure the Mask Strap junction is resting at the lowest part of the head near the top of the neck in an even position and not off to one side.



4. Pushing the mask up onto your face, get your chin and the nose dam positioned comfortably into the mask, then lightly tighten the Temple Straps first only enough to position the larger area (junction) of the harness at the back of the head and as low as possible.



5. Lightly tighten the lower Jaw Straps, and then lightly tighten the temple straps alternating between the two until the fit is evenly positioned.

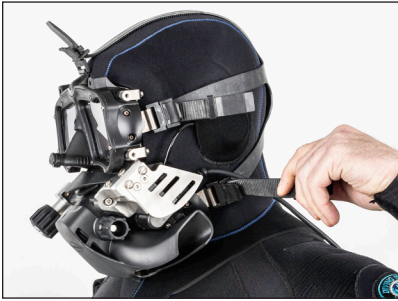

The top strap should not be tightened much, but is mainly used to locate the rear mask strap junction. If you feel it is necessary to adjust it, do so after all side straps have been adjusted.

Equalizing



The nose pocket contains a mechanical equalizing device held in place from the outside of the nose pocket with a low-profile tie-wrap. This advanced feature has been added to assist in pinching the nose throughout a wide range of nose and face sizes while wearing the bulkiest of gloves. Because the actual nose pocket of the mask is very flexible, it allows the pocket to be moved slightly in towards the face and can also be flexed side to side to get the best possible function of the nose pinch assembly. This device is very effective as installed and can be removed if needed to modify or clean.

Water Entry

Many methods of water entry are possible due to the secure nature of the mask seal. However, the diver should hold the mask & demand regulator firmly against the face when doing a roll off or drop type entry.

Once in the water, the diver should recheck mask fit and re-adjust the strap as needed, check the regulator for ease of breathing, and perform a communications check.

Regulator Adjustment Knob

The purpose of this adjustment knob is to allow the diver the ability to compensate for variations in umbilical supply pressure. This adjustment device operates by simply increasing or decreasing the amount of spring bias tension on the demand regulator inlet valve.

This adjustment device is not intended as a minimum-maximum device. Minimum and maximum applies to supply pressure only. The adjustment knob should be adjusted by the diver to be at the easiest breathing setting at all times.

This demand regulator can be adjusted by the diver during the dive by simply rotating the spring bias adjustment OUT (counter clockwise) to make the demand valve more sensitive or IN (clockwise) to make the demand valve less sensitive to the supply pressure.

It may be necessary for the diver to readjust the demand regulator by means of the adjustment knob once at the work site to compensate for the variation in umbilical supply pressure.



NOTE

The design of the adjustment knob allows very rapid movement, so changes in the regulator will happen more quickly (4:1 ratio).

Supply Pressure

The proper supply pressure is important to ensure maximum overall breathing performance. The minimum recommended and maximum supply pressures found in the Torque Specs and supply pressure requirements module will allow for at the very least a respiratory work rate of 75 RMV at all depths listed.

The low pressure supply tables were developed to simplify calculation of supply pressure. In order to get the required volume to the diver, you need to have the proper supply pressure. The table starts at 90 psig and increases in 10 psig increments. The user simply selects the lowest pressure that best represents the low cycling pressure of the compressor being used. The table basically shows the maximum depth that can be attained

while breathing at *different* RMV's (*breathing rates in liters per minute X amount breaths per minute*) listed. It is strongly recommended that divers plan for a minimum supply pressure that will allow the diver to work at no less than 50–62.5 RMV.

Dive Lab, Inc. of Panama City Beach, Florida develops all performance standards and requirements for all Kirby Morgan Helmets, Full Face Masks and associated equipment.

For the greatest details and complete list of supply pressure tables on supply pressure parameters for the Surface Supplied MOD-1 are located in the Torque Specs and supply pressure requirements module on the KMDSI website.

Lens De-Fogging

A slight opening of the control knob is all that is needed to clear the lens, while inhaling through the nose will work well. There should be sufficient gas flow to obtain a comfortable breath. Because this breathing cavity is basically two separate chambers, the de-fogging process will work most efficiently by inhaling through the nose and exhaling through the mouth. Cycling all breathing through the nose, although possible, will diminish the defogging process efficiency. It is also possible to inhale through the nose **WITHOUT** using steady flow, but this may cause some light regulator pulsating/vibration, but remember to exhale through the mouth. Exhaling through the nose may re-introduce fogging of the lenses.

Emergency Procedures

Mask Clearing and Dewatering

To clear water from the lens body.

1. Maintain a face forward position with your mouth closed and open the steady flow valve.

In the event of partial or complete flooding, the diver may clear the mask quickly by tilting the mask down and opening the defogger control knob. With the mouth closed pressing in on the manual purge button in the center of the regulator cover will evacuate water from the regulator, if any still remains, repeat the process.

Main Supply Gas Flow Stops

A stop of flow in the demand regulator usually indicates the main gas supply has stopped. The diver should first open the emergency valve by pulling the EGS knob out (away from the mask) turning the knob backwards. **THIS IS A QUARTER TURN VALVE. DO NOT TRY TO TURN THIS KNOB MORE THAN A QUARTER TURN!** Once the control has reached the appropriate

position, The control has a spring assist to help re-engage the clocking pin. To make certain the control knob has been locked into that position, make sure by lightly trying to rotate the knob. This will verify the engagement of the clocking/safety pin to prevent unwanted movements. If there is still no flow from the demand regulator, the defogger valve knob should be opened. Keep in mind that if the defogger valve is left open, the bailout bottle will drain very quickly, particularly if the diver is deep.

Immediately notify topside, check to ensure your umbilical is clear and return to the diving station using the emergency breathing supply. Avoid making a rapid ascent if at all possible.

⚠ DANGER

Rapid ascent is dangerous. It can lead to air embolism or decompression sickness. Air/gas embolism can cause immediate loss of consciousness and/or death. Even on a no decompression dive, a rapid ascent may cause decompression sickness. A diver must only make a rapid ascent when they are in immediate danger of death by drowning or asphyxiation.

Demand Regulator Free Flow

If the demand regulator free flows, adjust the knob in (clockwise or toward the diver's face) until it stops. If free-flow continues, open the defog valve all the way. This can sometimes lessen the flow to the demand regulator and terminate a free flow. If the free flow cannot be stopped, the dive should be aborted. Even if there is no serious problem to the diver, the dive should be aborted and the problem with the regulator corrected.

Removing the Mask

The mask can be removed by pushing forward on the release tabs of the two lower jaw strap Buckle Assemblies while pushing the lower half of the mask away from the chin. This will allow the mask to be removed by pulling it up and over the face and clear of the head. It is also possible to push outward on both the Temple and Jaw strap buckle assemblies in a controlled manner, and then proceed to push the entire mask away from the face.

Post Dive Procedures/Checklist

Complete Post-Dive procedures can be performed with the attached hood in place and under standard use does not need to be dismantled. If sepa-

Cleaning Procedures

ration of components is required simple steps can be done in a relatively short time. Order of separation should be:

- Mask strap
- Earphone removed from holders
- Hood
- Pod (Regulator & Side Block)

Completely inspect the M-48 MOD-1/SuperMask® and Pod and all related gear after each dive in accordance with the checklist in the following Post-Dive Cleaning and Inspection to ensure that all components are in proper working order.

To reference the Post Dive Checklist and all inspection checklists for the Surface Supplied MOD-1 click checklists under the support tab at Kirbymorgan.com

CAUTION

When not in use, component inlet/outlet ports shall be protected with clean, dry dust caps. Otherwise, contaminants or debris can enter and cause malfunction, leading to accidents and/or injury.

Cleaning Procedures

After each day of diving, or between use by different users, the mask, and Pod, should be carefully cleaned and visually inspected and sanitized, sanitizing the mask and Pod should be done after cleaning has been completed.

Cleaning should be accomplished using a mild hand type dish washing soap and cleaning rag. Mix the soap and water approximately 1 tablespoon per gallon of water. Wet all components of the mask and agitate using a cleaning rag. Keep the soap solution in contact with the mask surfaces for at least three to five minutes then thoroughly rinse with clean fresh water and dry. The mask should be transported and stored, completely dried, in the storage bag.



The hood can easily and quickly be removed after cleaning to hasten drying time and allow complete drying before storage.

NOTE

⚠ CAUTION

Clean and sanitize this mask using only the procedure described in this user's guide. Never use cleaning solvents or petroleum-based chemicals on this mask.

During a standard overhaul, parts should be cleaned in a warm water and mild soap solution, with a clean rag, and thoroughly rinsed in clean water. Hand dishwashing soap like Joy®, Dawn® or Palmolive® can be used.

Completely inspect the Surface Supplied MOD-1 and all related gear after each dive in accordance with the Post-Dive Cleaning and Inspection checklist to ensure that all components are in proper working order. Checklists for all KMDSI products are found on the KMDSI website under the support tab.

⚠ WARNING

Always sanitize all diving components an individual will be exposed to prior to use by another person. Failure to do so could result in the transmission of communicable diseases, some of which may cause long term disability or death.

⚠ CAUTION

Carefully dilute germicidal cleansing solutions in accordance with manufacturers' recommendation. If solution is not of the recommended strength, it will not act as an effective disinfectant and the spread of sickness may result.

⚠ CAUTION

Failure to thoroughly rinse germicidal cleansing solution from the diving equipment may result in lung irritation and/or long-term degradation of rubber and silicone components.

Sanitizing of the mask and Pod is accomplished using one of the approved germicidal cleansing solutions listed in "Germicidal Solutions Manufacturers" on page 34. Follow the manufacturer's mixing instructions and procedures. It is important to thoroughly rinse with fresh water.

General guidelines are as follows: Wet or immerse all components to be sanitized. Allow to stay in contact with solution for at least ten minutes while lightly scrubbing over components with nylon toothbrush or clean cloth to help remove mucous or saliva build up. If germicidal solution ap-

pears to be drying, apply more solution to keep components wet for full ten minutes. After ten minutes, thoroughly rinse components under fresh (potable) running water while brushing or rubbing components.

If equipment is not being used immediately, allow components to air dry or pat dry with clean towel and reassemble.

Germicidal Solutions Manufacturers

1. **SaniZide Plus:** P/N: 34805 (spray) or 34810 (gallon), Ready to use; do not dilute. 1-800-456-7077 <http://safetec.com/products/>
2. **MSA Confidence Plus:** P/N 10009971 (32 ounces) Mix one ounce of concentrate with one gallon of fresh water.
3. **Steramine™:** Steramine Quaternary Sanitizing Tablets - 150 Sanitizer Tablets per bottle 1 Tablet per gallon of water - Makes 150 gallons of cleaning solution <http://steramine.com/>

NOTICE

Store spare valves, and soft goods in a cool, dark, dry place. Avoid prolonged exposure to temperatures above 90 °F (32 °C) and/or exposure to ultraviolet rays or chemical fumes.

Conservation and Storage

Ensure the mask and Pod is thoroughly dry before storing.

Store the mask and Pod at room temperature and out of direct sunlight.

⚠ WARNING

When purchasing spare parts, always insist on Kirby Morgan Genuine Parts. Although other parts may look the same, they may not be manufactured to the same standards of quality. Improperly manufactured parts can cause accidents that can lead to injury or death.

Scheduled Maintenance

This user guide provides properly trained personnel with the guidance and technical information needed to perform normal scheduled maintenance and adjustments as described herein. Repairs and overhauls must be completed by Surface Supplied Pod Assembly authorized trained technicians.



Read and understand each section before attempting the procedures in the tables found in the user guide.



Before scheduled maintenance is performed, all components should be thoroughly cleaned in accordance with the procedures found in "Cleaning Procedures" on page 32.

Disassembly Guidelines

Routine cleaning and maintenance is the best way to ensure long equipment life and optimum performance.

Adjustments and Minor Repairs

It is best to look over and familiarize yourself with the associated exploded view drawings prior to performing adjustment or minor repairs.

Supply Pressures

The proper supply pressure is important to ensure maximum overall breathing performance. The minimum recommended and maximum supply pressures listed below will allow for at least a respiratory work rate of 75 RMV at all depths listed.

DEPTH		MIN. SUPPLY PRESSURE		MAX. SUPPLY PRESSURE		NORMAL/ RECOMMENDED SUPPLY PRESSURE	
FSW	MSW	BAR	PSIG	BAR	PSIG	BAR	PSIG
0-50	0-15.2	7	100	19.6	275	8.6	125
50-100	15.2-30.5	10.3	150	19.6	275	12	175
100-125	30.5-38	12	175	19.6	275	13.8	200
125-145	38-44	13.8	200	19.6	275	15.5	225
145-165	44-50.3	15.5	225	19.6	275	17.2	250
165-190	50.3-58	17.2	250	19.6	275	17.2	250

When the diver is working at light to heavy work rates, (15–50 RMV) the minimum recommended Supply Pressure for a particular depth, should offer the smoothest overall performance. Use of the maximum pressure should only be needed at a depth of 165 FSW (50 MSW) or deeper in the event the diver is breathing at the extreme work rate of 75 RMV or greater. The maximum supply pressure is listed primarily due to European CE requirements which requires the maximum and minimum supply pressures be listed. The minimum supply pressures for the depths listed below will allow for a work rate of 75 RMV IAW the CE requirements of EN15333-1.

Performance is based on a minimum of 75 RMV to depths of 165 FSW (50 MSW) using a $\frac{3}{8}$ " (9.5 mm) umbilical 600 foot (183 meters) long, made up of two 300 foot (91 meter) sections.

Accessories/Spares

Prescription Lenses

The following website is available to install prescription lenses Into your MOD-1 mask:

<https://prescriptiondivemasks.com/>

Jumper Hose P/N 855-010



A “jumper” scuba hose must always be used to connect the main gas supply through a one way valve and to the side block on the pod. A big bore “jumper” hose comes with the pod which includes an adapter to secure the one way valve directly to the umbilical gas supply hose.



NOTE

If using a KMDSI Manifold Block Assembly with One Way Valve, a longer hose from the Manifold Block to the side block fitting can be used instead of the Jumper Hose/One Way Valve that comes with the mask.

Over-Pressure Relief Valve P/N 200-017



This valve is designed to be mounted on a first stage bail-out regulator for surface-supplied diving. It allows pressure to bleed from the intermediate pressure hose in the event of a “creeping” first stage. Without this valve, the intermediate pressure hose would burst and the diver would lose his entire emergency gas supply. (Torque specification for installing into low pressure port of first stage regulator: 20 inch pounds).



One-Way Valve Assembly P/N 505-060

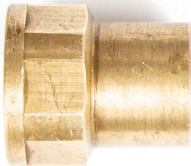

Adapter P/N 850-155

KMDSI Mask Bag P/N 800-905



A convenient Mask Bag is available for storage and transportation of the mask, pod, and regulators.

MOD-1 Hood Assembly w/ Bib L/XL, 7 mm P/N 805-125



The 7 mm hood currently does not include a Hood Mount Stud block and is only available in one size.

Hood Mount Stud Block P/N 850-095



This stud block allows easy removal and replacement of the hood without the use of tools. The block has a threaded center hole that can be used for attaching or mounting HUD, light or camera brackets. It is 10-24 UNC $\frac{3}{8}$ " depth.

This page intentionally left blank



Kirby Morgan Dive Systems, Inc.

1430 Jason Way

Santa Maria, CA 93455, USA

Telephone (805) 928-7772

FAX (805) 928-0342

E-Mail: kmdsi@kirbymorgan.com

Web Site: www.kirbymorgan.com