

# KM Diamond

## Contents

<b>DIAMD-2</b>	<b>1.1 General Information about the KM Diamond</b>	<b>DIAMD-13</b>	<b>1.6 Diamond Subassemblies Removal</b>
DIAMD-3	1.1.1 Basic System Overview	DIAMD-13	1.6.1 General Information
DIAMD-3	1.1.2 Diamond Pod Subassembly	DIAMD-13	1.6.2 Tools Required
DIAMD-3	1.1.3 Diamond Exhaust Assembly	DIAMD-14	1.6.3 Removing Diamond Components
DIAMD-4	1.1.4 Surface Bypass Valve Assembly	DIAMD-14	1.6.4 Removal of the Diamond Exhaust Assembly
DIAMD-5	1.1.5 Water Purge Assembly	DIAMD-15	1.6.5 Removal of the Surface Bypass Valve
DIAMD-5	1.1.6 Specifications	DIAMD-16	1.6.6 Removing the Surface Bypass Hose
<b>DIAMD-6</b>	<b>1.2 Components</b>	DIAMD-16	1.6.7 Removing the Hose Fitting Adapter
DIAMD-6	1.2.1 Diamond Pod	DIAMD-16	1.6.7.1 Inspection of the Butterfly Valve
DIAMD-7	1.2.2 Diamond Main Tube	DIAMD-17	1.6.8 Removal of the Water Purge Assembly
DIAMD-7	1.2.3 Diamond Oral Nasal Mask and Oral Nasal Insert	DIAMD-17	1.6.9 Removing the Diamond Main Tube
DIAMD-8	1.2.4 Diamond Exhaust Assembly	DIAMD-18	1.6.10 Removing the Diamond Oral Nasal Mask and Oral Nasal Insert
DIAMD-8	1.2.5 Surface Bypass Valve	DIAMD-19	1.6.10.1 Removing the Oral Nasal Mount
DIAMD-9	1.2.6 Water Shrouds	DIAMD-19	1.6.10.2 Removing the Inhalation Tube
DIAMD-9	1.2.7 Constant Water Supply System	DIAMD-19	1.6.10.3 Removing the Purge in the KM Diamond Pod
DIAMD-9	1.2.8 Bypass Equalizer Tube	DIAMD-19	1.6.10.4 Removing the Hex Insert
DIAMD-9	1.2.9 Exhaust Hose	DIAMD-20	1.6.11 Removal of the Diamond Pod
<b>DIAMD-10</b>	<b>1.3 Pre-Dive Procedures</b>	DIAMD-21	1.6.12 Removal of the Water Shrouds
DIAMD-10	1.3.1 Helmet	DIAMD-22	1.6.12.1 Removal of the Diamond Valve Shroud
DIAMD-10	1.3.1.1 Quick Guide	DIAMD-22	1.6.12.2 Removal of the Water Tube A & B with Adapter Sleeves
DIAMD-11	1.3.2 Topside	DIAMD-23	1.6.12.3 Removal of the Inhale Regulator Shroud & Access Cover
<b>DIAMD-12</b>	<b>1.4 Operating Instructions</b>		
DIAMD-12	1.4.1 Supply Pressure Requirements		
DIAMD-12	1.4.2 Back Pressure		
DIAMD-12	1.4.3 Helmet		
<b>DIAMD-12</b>	<b>1.5 Emergency Procedures</b>		
DIAMD-12	1.5.1 Flooding		
DIAMD-13	1.5.2 Return Line System Failure		

DIAMD-24	1.6.12.4 Removal of the Side Block Shroud	DIAMD-32	1.7.10 Installing the Purge Valve in the KM Diamond Pod
<b>DIAMD-25</b>	<b>1.7 KM Diamond Installation</b>	DIAMD-33	1.7.11 Installing the Oral Nasal Mount
DIAMD-25	1.7.1 General Information	DIAMD-34	1.7.12 Installing Inhalation Tube on the inside of the Diamond Pod
DIAMD-25	1.7.2 Installing the Hex Insert	DIAMD-34	1.7.13 Installing the Diamond Oral Nasal Mask and Oral Nasal Insert
DIAMD-26	1.7.3 Installation of the Diamond Pod		
DIAMD-27	1.7.4 Installing the Diamond Main Tube		
DIAMD-28	1.7.5 Testing Demand Regulator for Correct Adjustment	<b>DIAMD-36</b>	<b>1.8 Installation of the Water Shrouds</b>
DIAMD-28	1.7.6 Adjusting Diamond Main Tube	DIAMD-36	1.8.13.1 Installation of the Side Block Shroud
DIAMD-29	1.7.7 Installation of the Water Purge Assembly	DIAMD-37	1.8.13.2 Inhale Regulator Shroud & Access Cover
DIAMD-31	1.7.8 Installation of the Surface Bypass Valve	DIAMD-37	1.8.13.3 Installation of the Water Tubes A & B with adapter sleeves
DIAMD-31	1.7.9 Installation of the Diamond Exhaust Assembly	DIAMD-39	1.8.13.4 Installation of the Diamond Valve Shroud

## 1.1 General Information about the KM Diamond



**First Look at the Kirby Morgan® Diamond™**

[https://www.youtube.com/watch?v=L-m\\_iumAltU](https://www.youtube.com/watch?v=L-m_iumAltU)



**The Kirby Morgan Diamond®**

<https://www.youtube.com/watch?v=vYFEaJ4UdfI>

The Kirby Morgan Diamond is specially designed to be part of a surface supply and exhaust return diving system. The helmet offers an extremely high level of protection for divers diving in dirty water. The same basic system can also be used for diving in potable water systems as well as water systems that cannot tolerate contamination from the diver or the diver's equipment. This would include potable water systems as well as highly refined water such as those found in power plants. Lastly, the Diamond can also be used for saturation bell diving where the reclamation of the divers HeO<sub>2</sub> breathing mixture can be reclaimed, reconditioned, and re-used with a very high degree of reclamation efficiency.

The Kirby Morgan Diamond can be used with the current reclaim systems used in the commercial diving industry.



If the Kirby Morgan Diamond is subjected to petroleum based liquids in dirty water, P/N 525-386 KM Diamond Dirty Water Conversion Kit is available. The valves in this conversion kit are made from different material from those that are used in the standard Diamond Diving System. This difference in material will further protect the soft goods of the helmet.

The entire breathing system of the Kirby Morgan Diamond Helmet can be covered by interconnected chemically resistant Shrouds. The Shrouds direct a constant flow of clean non-dirty water to surround the critical parts of the breathing system. The Shroud system can also be used with a hot water supply to both protect and warm the diver's inhalation gas at the same time.

Another significant benefit to using the KM Diamond diving system is the elimination of exhaust noise that is created by expanding gas bubbles exiting open circuit exhaust valves. This in turn noticeably improves all communications between divers and topside to diver communications.

The use of titanium in many of the main components ensures the helmet weight and balance remain precise, while at the same time, providing a

very high level strength and corrosion resistance, not available on any other system of its type.

The benefits from the elimination of bubbles and having the exhalation routed to the surface include:

- Greater contaminant protection
- Increased clarity with communications
- No disruptive bubbles in closed environments
- Operational savings (with gas reclaim system)

### 1.1.1 Basic System Overview

The major components that make up the Kirby Morgan Diamond System are:

- Diamond Pod P/N 505-385
- Diamond Exhaust Assembly P/N 505-400
- Surface Bypass Valve Assembly P/N 505-375
- Water Purge Valve Assembly P/N 505-378

Regardless, if the diver's exhaust is simply vented at the surface to the immediate atmosphere, or routed through a reclaim system and returned to the diver, the entire system, as well as approved support components and systems, must be used and configured, as explained within this operations manual.

This manual is primarily intended to provide basic user information to ensure proper function and use. It is strongly recommended that overhauls and repairs be completed by properly trained technicians only.

Technical training is available to all. For training information, call or e-mail Dive lab Inc. [www.divelab.com](http://www.divelab.com), (850) 235-2715 or Kirby Morgan Professional Dive Center [www.kirbymorganpro.com](http://www.kirbymorganpro.com), (805) 739-1909

### 1.1.2 Diamond Pod Subassembly

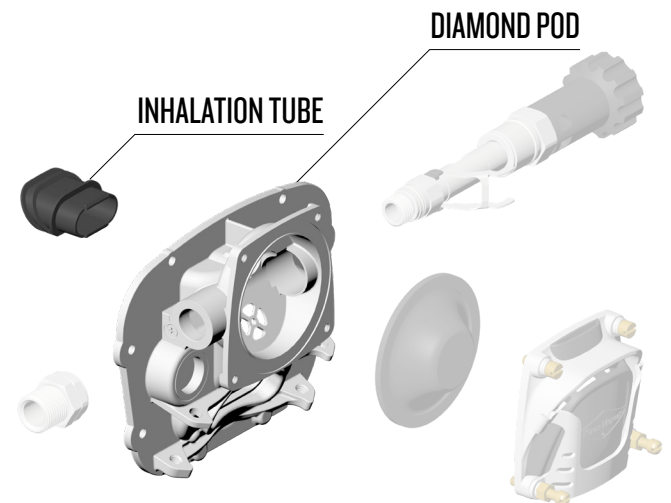

The Kirby Morgan stainless steel helmets pioneered the use of a unique Pod system. The Diamond Pod is distinct as the demand supply regulator body is built into the Pod and is designed for use only with the Diamond diving system. The demand supply regulator body is cast into the stainless steel Pod assembly as one unit with the regulator internals based on the 455 Balanced Regulator. Besides housing the demand supply regulator body the Pod subassembly is the foundation and interface point for the two stage Diamond Exhaust Assembly that controls and routes the diver's exhaled gas. Associated parts unique to the Pod are a distinct oral nasal mask that is secured with a mounting plate. Stabilization and proper positioning of the oral nasal mask is also assisted by the addition of an inhalation tube.

### 1.1.3 Diamond Exhaust Assembly



Only Technicians who have valid technician training for the Diamond Exhaust Assembly should perform service or repair work.

**SURFACE BYPASS HOSE CONNECTION  
(EXHAUST PATHWAY)**

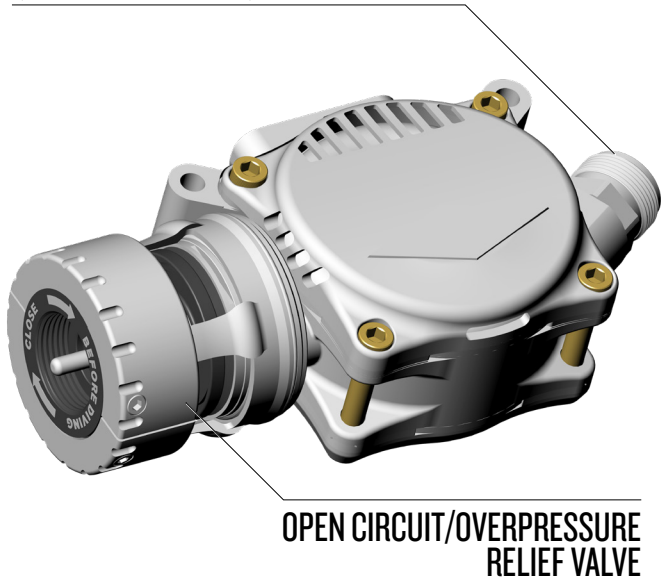

The Diamond Exhaust Regulator is a two stage exhaust regulator that controls the pressure (positive and negative) of the exhaled gases. The divers exhaust travels through the Diamond Exhaust regulator then through the Surface Bypass Valve down to the surface return line system. On the starboard (right side) of the Diamond Exhaust regulator is an Open Circuit/Overpressure Relief Valve used in an emergency and to prevent injury to the diver in the event the helmet is inadver-

tently over pressurized. It can also be adjusted to improved breathing performance when operating in the open circuit mode.

**1.1.4 Surface Bypass Valve Assembly**

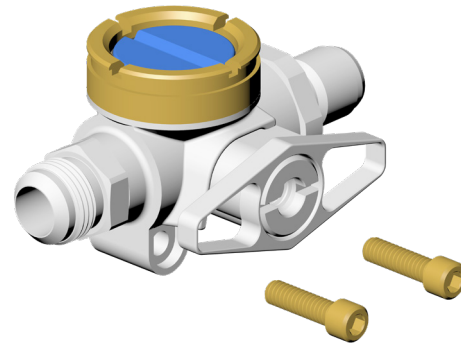

The Surface Bypass Valve is located on the port (left) side of the helmet. The Surface Bypass Valve allows the diver to manually route the exhaust to the surface return umbilical or switch to open circuit mode in the event of a return line failure. About a ¼ turn on the diamond shaped control handle is all it takes to instantly switch back and forth between the two dive modes.

The Surface Bypass Valve is paired with an Bypass Equalizer Tube that captures and routes the exhaust bubbles through internal channels when operating in open circuit dive mode. Benefits of this system are a stabilized supply regulator,

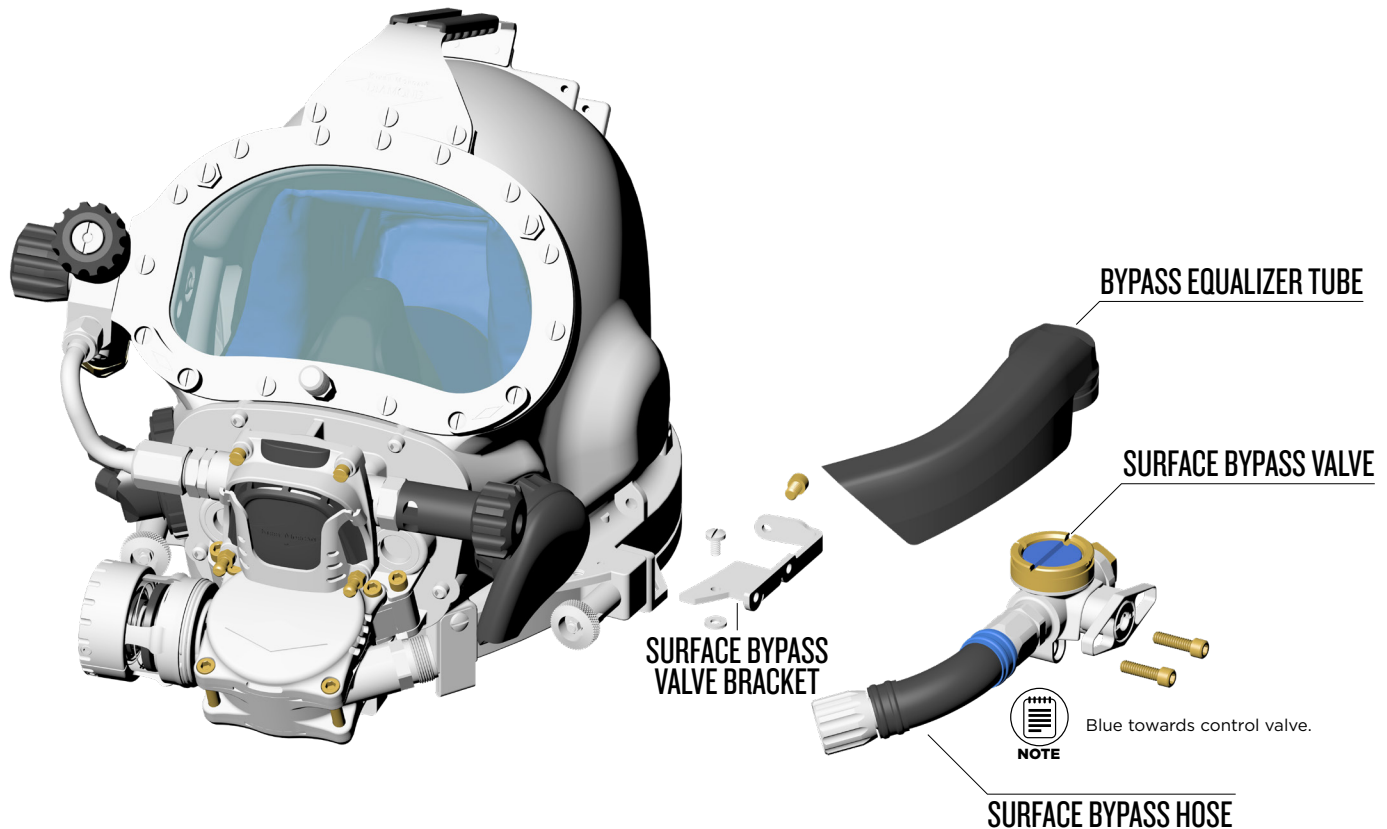

**⚠ SHROUDS HAVE BEEN REMOVED TO ALLOW VIEWING OF ALL MAJOR COMPONENTS**

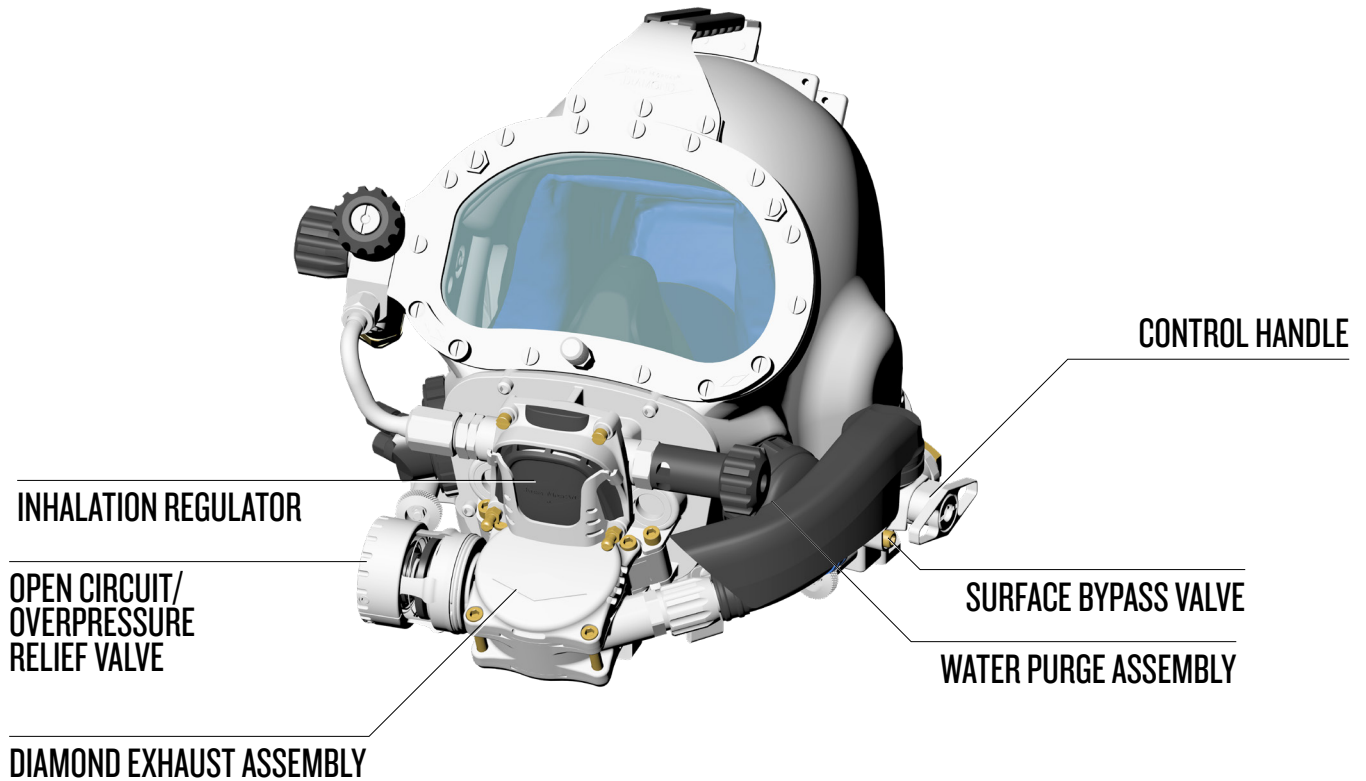

protective bubble layer to the enclosed exhaust valve and deflection of exhaust bubbles from the diver's field of view.

**1.1.5 Water Purge Assembly**

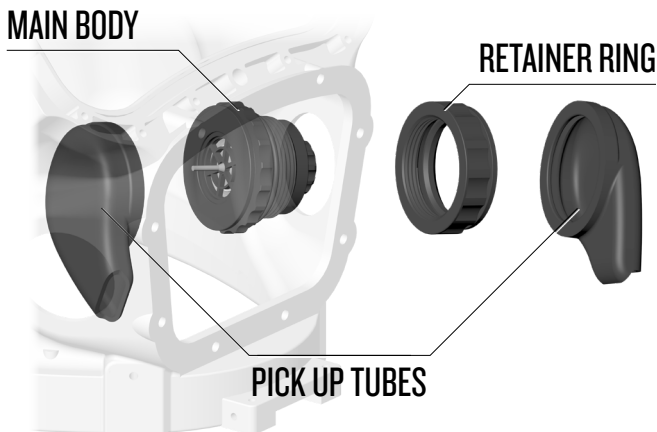

Mounted to the port side of the helmet there is a dewatering valve. This valve can also open when the helmet experiences excessive gas flow or is over pressured by the diver using the defogger valve.

The assembly is made up of four major components. Two Pickup Tubes (one on the inside and one on the outside of the helmet), the main body (located on the inside of the helmet) and the Retainer Ring (located on the outside of the helmet).

**1.1.6 Specifications**

- Inhalation Second Stage Type: Downstream, Balanced Bias Adjustable.
- Regulator Body/Pod: 316L Stainless Steel
- Diamond Exhaust Valve, Main Components: Titanium/316L Stainless Steel
- Surface Bypass Valve: Titanium/316L Stainless Steel
- Other misc. parts: ABS + PC, PPO + GF, PPS, ABS, Titanium, silicone, bronze, POM, Nylon, polyurethane, 300 series stainless steel, liquid silicone, PP, Buna N.
- Recommended Lubricants: Christo-Lube®,

Tribolube®, MOLYKOTE® 111 lubricant (when noted)

## 1.2 Components

### 1.2.1 Diamond Pod

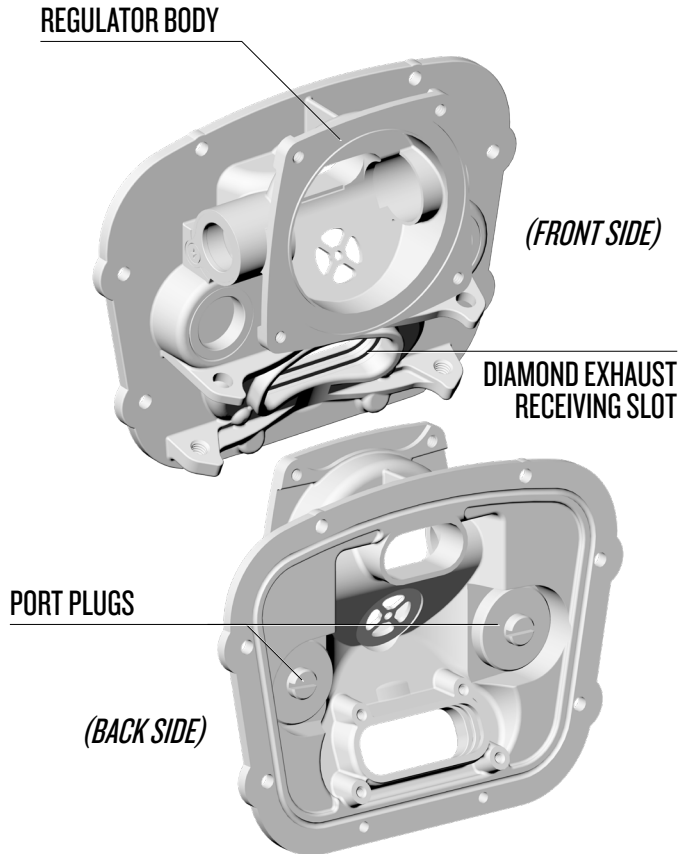

Under normal conditions, it is not necessary to remove the Pod to service the supply regulator or the three main components of the Diamond diving system. However, during overhauls the Pod should be removed at least every three years for inspection and gasket replacement.

The Diamond Pod includes the inhalation regulator body, a lower receiving slot to accept the Diamond Exhaust assembly with screw holes on the inside of the Pod for attaching a dedicated oral nasal mount and an upper slot for the inhalation tube. All Diamond Pods are serial numbered on the inside. The Diamond Pod is the only major part of the Diamond System that is not Titanium.

Diamond Pod distinct characteristics:

- Inhalation regulator body is part of the Pod
- Oral Nasal Mount attaches directly to the Pod
- Contains two port plugs

- Two static O-rings are located in the receiving slot
- The two bottom fasteners retaining the Pod are pan head slotted screws that are secured from the inside of the Pod

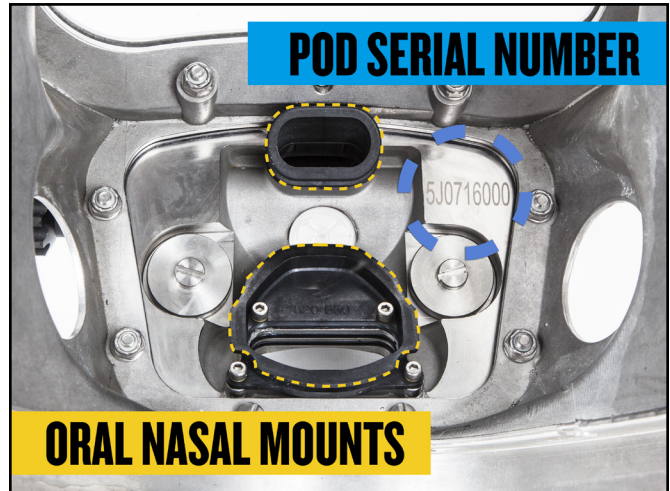

*The serial number for the Pod can be found on the upper right side on the inside of the Pod.*

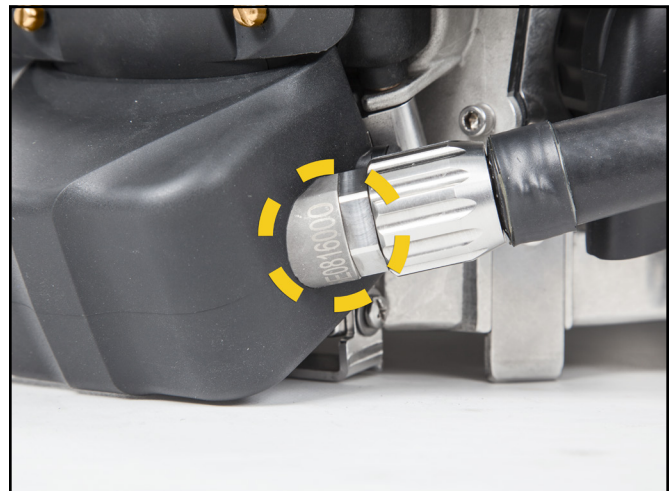

*The serial number for the Diamond Exhaust Assembly can be found on the Diamond Exhaust Main Body.*

## 1.2.2 Diamond Main Tube

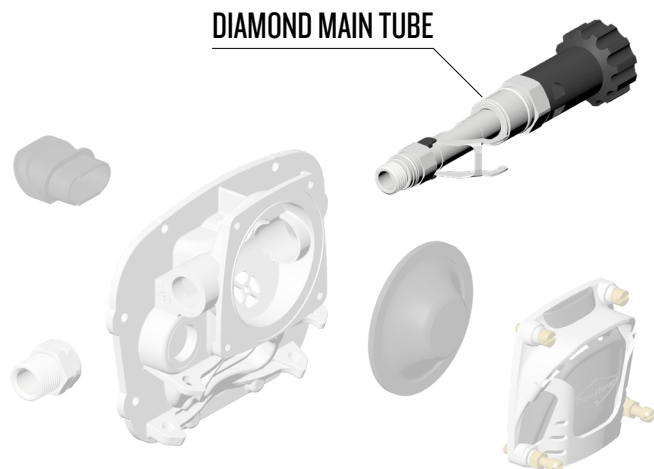

Diamond Main Tube is unique to the Kirby Morgan Diamond® and will not fit any other Kirby Morgan helmets or BandMasks®.

The inhalation regulator is based on the Balanced 455 demand regulator P/N 505-455. All individual parts inside the main tube assembly, but **NOT THE MAIN TUBE**, are interchangeable. To remove and/or replace the Diamond Main Tube, the Hot Water Tubes A and B, Bent Tube, Bent Tube Adapter and Regulator Retainer Cover Assembly will all have to be removed first.

This demand regulator can be adjusted by the diver during the dive by simply rotating the Flex Knob. The full range of rotation is approximately seven full turns.

In normal operation the demand adjustment should be set at the lightest cracking pressure by rotating the adjustment knob OUT away from the helmet (counterclockwise) until a slight free flow develops and then rotate it IN towards the helmet (clockwise) until the free flow stops. At this point the diver will be taking full advantage of the demand valve's performance.

The **Flex Knob** will **never bottom out or stop turning in towards the helmet** (clockwise direction). When full inward travel is reached, a slight clicking sound can usually be heard. The clicking is an audible indication the adjustment knob is completely positioned and the tension of the bias adjustment spring is as tight as it will get. The Flex Knob will stop in the counter clockwise position (turning the knob away from helmet). This is the position that indicates the tension of the bias adjustment spring is at its least amount

of resistance. A free flow of gas will occur in this position.



**NOTE**

When storing the helmet for any length of time, ensure that the Flex Knob, for adjusting the regulator, is turned "out", away from the helmet (fully counterclockwise), to avoid stressing the bias spring. This will prolong the life of the inlet valve, seat, and bias spring.

## 1.2.3 Diamond Oral Nasal Mask and Oral Nasal Insert



The Diamond Oral Nasal Mask and Oral Nasal Insert are unique features of the Kirby Morgan Diamond. Due to the Inhalation Regulator Body being built into the Diamond Pod, there is not a Regulator Mount Nut for the oral nasal mask to attach to. Dedicated, removable Oral Nasal Mounts are used to mount the Diamond Oral Nasal Mask to the Pod.

The Diamond Oral Nasal Insert is a patented Kirby Morgan breathing enhancement component that improves regulator performance, controls and lowers the CO<sub>2</sub> levels and keeps them to a minimum. It is easily Installed and Removed and is Secured into the Oral Nasal Mask by the Nose Clearing Device.

Both of the Oral Nasal Mask Mounts are removable. The Inhalation Tube is secured into the Diamond Pod by a push in/snap fit and the lower Oral Nasal Mount Plate is secured to the Pod with four stainless steel screws with brass washers.

## 1.2.4 Diamond Exhaust Assembly

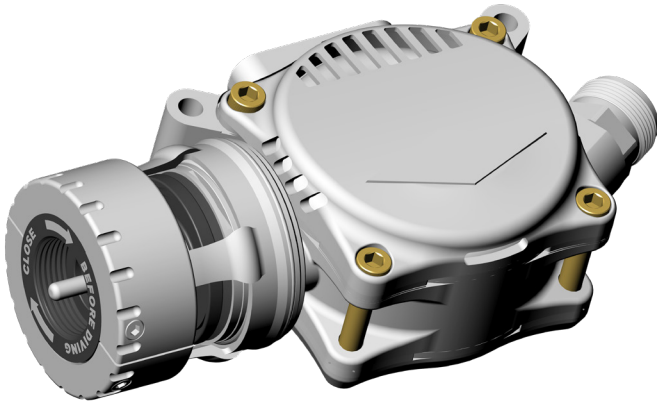

The Diamond Exhaust assembly directs and routes the diver's exhalation gas to the surface or recovery station. The design assists the diver's work of breathing by dramatically reducing exhaust resistance. This assembly also houses the Open Circuit/Over Pressure Relief Valve. It is found on the right side of the assembly below the helmet's side block. To release spring tension and set to open circuit mode, turn the control knob counter clockwise, approximately  $\frac{1}{2}$  turn, until it stops. If not using this valve for open circuit, make certain that it is tightly closed.



*The Open Circuit/Over Pressure Relief Valve is found on the right side of the Diamond Exhaust Assembly, below the helmet's side block.*

The diver should always enter the water with the valve closed.

## 1.2.5 Surface Bypass Valve



**NOTE**

Full complete handle movements must be made when turning control handle. NEVER leave control handle in a halfway position.

The Surface Bypass Valve will allow the diver to switch from surface vent diving mode to open circuit diving mode with a  $\frac{1}{4}$  turn on the diamond shaped control handle found on the left side of the helmet. This valve is uniquely designed to not only isolate the return line from the diver to surface, it also instantly activates to an open circuit exhaust and water purging valve. This allows purging any water that may accumulate, from the interior of the exhaust valve system. With the required Bypass Equalizer Tube installed the valve is surrounded with an air cavity that isolates the valve from contaminants. It also provides equalizing for the valve to prevent free flow of the exhaust in the open circuit/bypass mode. This bypass adds additional safety to the user if failure were to occur with the surface venting exhaust hose or gas recovery system. The Surface Bypass Valve is connected to the Diamond Exhaust Assembly by a short flexible and easily removable hose.

The body is titanium and terminates with  $\frac{1}{2}$  inch NPT female stainless steel fitting. This type of termination allows the diver to use the NPT threads to mate the desired fitting specific to the job or location.

## 1.2.6 Water Shrouds

The water shrouds should be used anytime the system is operating in waters containing petroleum or chemical contamination that might degrade the diaphragms and open circuit exhaust valves. They are designed to be integrated with a constant water supply to further reduce the possibility of water entering the breathing system to further reduce the possibility of any dirty water that may be surrounding the diver from entering any of the breathing components or helmet interior.

The water shroud kit is made up of six separate main pieces. The side block and bent tube are completely encased while the remaining sub-assemblies are only slightly exposed in small areas to allow activation of the moving parts by the diver and to maintain a constant water flow over the entire Diamond system. Once the shrouds are installed they do not significantly interfere with the system operations or post dive procedures.

The inhalation regulator front cover/diaphragm is accessible by opening the access door that swings completely open for the technician to remove screws, cover guard, cover assembly and diaphragm. All post dive procedures can be **completed with the shrouds installed**.

Additional recommended use is whenever diving in water colder than 34 °F (1 °C). Operation should accompany the use of a hot water supply to help maintain breathing gas temperature at a level acceptable for use by the diver.

## 1.2.7 Constant Water Supply System

The water supply to the water shrouds for the diamond system should be from a salt or fresh water source that is considered clean enough to bathe in without incurring injury due to bacterial, viral, or chemical complications or damage from exposure.

## 1.2.8 Bypass Equalizer Tube



Made from the same chemically resistant material as the shrouds this channelled tube is secured on top of the Surface Bypass Valve. Once the Surface Bypass Valve is activated (turned to open circuit mode) the bubbles exiting the helmet are captured and channelled through the Bypass Equalizer Tube to balance the supply regulator with the surrounding pressure in the water column. The escaping bubbles form a protective layer to the valve and the internal channel configuration will route the exhaust bubbles away from the field of view from the diver. Design features allow exhaust bubbles to be released from the front or the back of the tube. This ensures low exhalation effort when the Surface Bypass Valve is activated regardless of diver orientation. The tube is not required to be removed for post dive procedures.



### NOTE

If the helmet will be used on open circuit for extended periods, the open circuit/overpressure relief should be rotated to the open position.

## 1.2.9 Exhaust Hose

The recommend exhaust hose of the umbilical should have a minimum  $\frac{5}{8}$ " inside diameter. The hose should be kink and crush resistant and have a rated working pressure of 120 psig minimum. The exhaust (reclaim) hose is connected to the helmet by your choice of fitting adapters. The  $\frac{1}{2}$ " NPT hose fitting adapter comes standard on the Surface Bypass Valve.

### Hose Fitting Adapter Options:

1. ½" NPT hose fitting adapter and ½" NPT to ⅜" NPT Hex Bushing (which is supplied but not installed).
2. ⅜" hose fitting adapter.
3. ½" Quick Disconnect

For best performance, the return line umbilical length should be no longer than 300 feet. These hoses are available from Dive Lab in 100' lengths with Quick Disconnect fitting to allow using a shorter hose if needed.

## 1.3 Pre-Dive Procedures

### 1.3.1 Helmet

The helmet should be pressure tested prior to the beginning of each diving day and includes:

1. Sealing the helmet with an appropriate test plug in the neck dam or Neck Ring of the helmet.
2. Set to Surface Vent mode, close the over pressure relief valve.
3. Add some gas into the helmet using the steady flow valve until gas escapes through Water Purge Assembly and OPRV. Close the steady flow valve.
4. Immerse the helmet in water and check for escaping gas.

Any bubbles will indicate a point of potential wa-

ter ingress/ gas loss in normal operation. Helmet should not be operated if a leak is observed.

Use the appropriate pre-dive inspection checklist found on either the KMDSI or Dive Lab website, <https://www.kirbymorgan.com/support/check-lists>, this will ensure that a methodical inspection of the Kirby Morgan Diamond and all related gear is completed before each dive.

#### 1.3.1.1 Quick Guide

Once the Helmet And Emergency Gas System Daily Set-Up And Functional Checklist is complete.

1. Breathe normally while turning the control handle HORIZONTAL to the Surface Vent/Reclaim position then VERTICAL to the Open Circuit position. Perform this action at least twice to become familiar with the operation of the control valve.
2. Ensure the **Open Circuit/OPRV** (Over Pressure Relief Valve on the right side of the diamond valve assembly) on the Diamond Exhaust is **closed** by rotating the open circuit control knob in a clockwise direction and verifying that it does not move.
3. Confirm **exhaust hose** is properly secured to the helmet.
4. Confirm constant water supply is secured to side block shroud inlet (if applicable).

Verify constant water supply is on and running at 1-1.5 minimum GPM, maximum, if applicable.

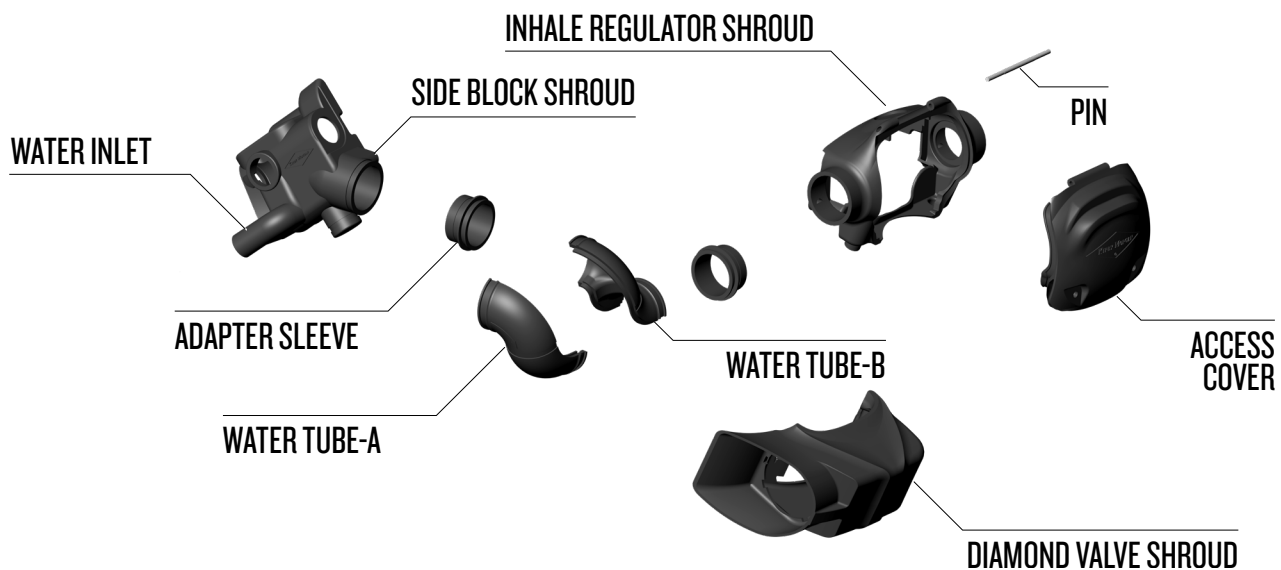

Water Shrouds

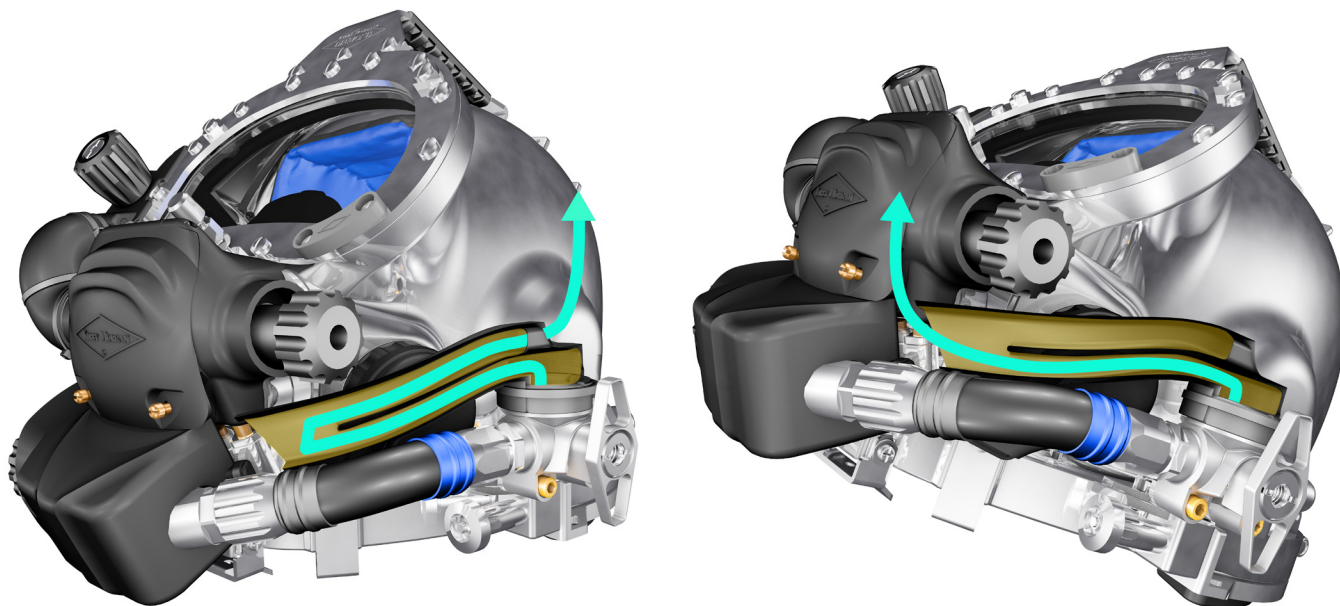

*Sectional View of the Bypass Equalizer Tube in the Open Circuit Position*

5. Confirm outside Pick Up Tube on the Water Purge Assembly is secured and in correct position.

**6. Open the steady flow valve slightly and keep it open until on the bottom.**

#### **TENDERS**

- Confirm Exhaust Hose is secured properly to helmet.
- Confirm Open Circuit/OPRV valve is shut
- Confirm SBV is in the Surface Vent (HORIZONTAL) position
- **ENSURE the steady flow valve is slightly open for descent (diver should close the valve when on the bottom).**

#### **EMERGENCY PROCEDURES**

##### **FAILURE of the topside vent control system or return line.**

1. Put helmet in open circuit mode immediately by turning the control handle past the VERTICAL position until it stops.
2. Open the Open Circuit/OPRV by rotating it towards the rear of the helmet (counter-clockwise). This will help to improve exhaust flow.

3. Notify topside that the diver is on open circuit and prepare to ascend.

#### **WATER INGRESS**

1. Slightly Open the steady flow valve  $\frac{1}{8}$  to  $\frac{1}{4}$  turn.
2. Turn the SBV handle backward to the open circuit position.
3. Lightly push in on the puck pin.
4. Slightly tilt the head to the left.

Once the water has been purged, turn the SBV control handle HORIZONTAL to the surface vent position then close the Steady Flow Valve.

#### **1.3.2 Topside**

With all pre-dive procedures and inspection checklists complete, additional tasks require attention.

The topside tenders and personnel must maintain the same vigilance with the diver's exhaust hose and surface return system as the supply hose and supply system.

If operating in the surface vent diving mode without a gas recovery system, the rack operator should make certain the hose is coupled to a surface vent control system, and have a visual of the end of the exhaust. It must also be secured to a permanent fixture during operations.

## 1.4 Operating Instructions

### 1.4.1 Supply Pressure Requirements

For the recommended supply pressure see tables "1.9 455 & KM Diamond LP Compressor Supply Table" on page SUPR-7 and "1.11 KM Diamond HP Regulated Supply Table" on page SUPR-10. They can be found in the Torque Specs & Supply Pressure Requirements module.

This should be used to guide the topside operator in correctly setting the supply regulator on the gas manifold box

### 1.4.2 Back Pressure

When operating the KM Diamond in surface vent mode (without a topside reclaim system) the exhaust hose back pressure should not be a concern until the diver reaches a depth of 100 fsw/30.48 msw or deeper.

When diving at or deeper than 100 fsw/30.48 msw, it is required to use a back pressure system to keep the helmet from activating and opening the water purge and over pressure relief valves.

As the diver descends beyond a depth of 4 ATA (100 fsw/30.48 msw) the diver's exhalation effort begins to increase. If the diver is working hard or breathing beyond the spring pressure found in the Water Purge Assembly and the Over Pressure Relief, the valves will open allowing gas to escape from one or both subassemblies possibly allowing contaminants into the helmet if operating in dirty water.

If diving to 100 fsw/30.48 msw or deeper it is required to use an exhaust back pressure system that can maintain and monitor the exhaust back pressures found in the KM Diamond Exhaust Back Pressure Flow Table "1.13.4 Table" on page SUPR-13 in the Supply Pressure Requirements & Tables module.

While Dive Lab, Inc. has a topside Diamond Exhaust back pressure system that is available it should be noted that all back pressure exhaust systems that can monitor and provide correct pressures found in "1.13.4 Table" on page SUPR-13 in the Supply Pressure Requirements & Tables module are acceptable.

### 1.4.3 Helmet

The helmet should be pressure tested prior to the beginning of each diving day and includes:

1. Sealing the helmet with an appropriate test plug in the neck dam or Neck Ring of the helmet.
2. Set to Surface Vent mode, close the over pressure relief valve.
3. Add some gas into the helmet using the free flow valve until gas escapes through the Water Purge Assembly and OPRV, then close valve.
4. Immerse the helmet in water and check for escaping gas.

Any bubbles will indicate a point of potential water ingress/ gas loss in normal operation. Helmet should not be operated if a leak is observed.



**NOTE**

**On descent the Free Flow valve must be slightly open.**

Diving the Diamond system is very similar to diving a standard KMDSI demand mode system with the exception being the descent procedures. The modification in descending in the water column requires the diver to **slightly open the Free Flow valve to ensure a light, but steady flow of gas is entering the helmet until the diver reaches the bottom.**



**NOTE**

When traveling to depth in a closed bell, the control handle on the surface bypass valve must be partially turned forward, where it is partially activated. Ensure the control handle is in the full-correct position before entering the water!

In normal operation the Over Pressure Relief/ Open Circuit Valve will be closed and the Surface Bypass Valve turned to the Surface Vent Mode (HORIZONTAL Position).

## 1.5 Emergency Procedures

### 1.5.1 Flooding

In partial or complete flooding, the diver may clear the helmet quickly by first deactivating the surface venting by the function of the surface bypass valve, then tilting the helmet down and opening the Steady Flow Valve. Pressing in on the manual purge button in the center of the regulator cover will evacuate water from the Oral Nasal Mask, if any still remains.

The water dump valve for the KM Diamond is located low on the left side of the helmet. By plac-

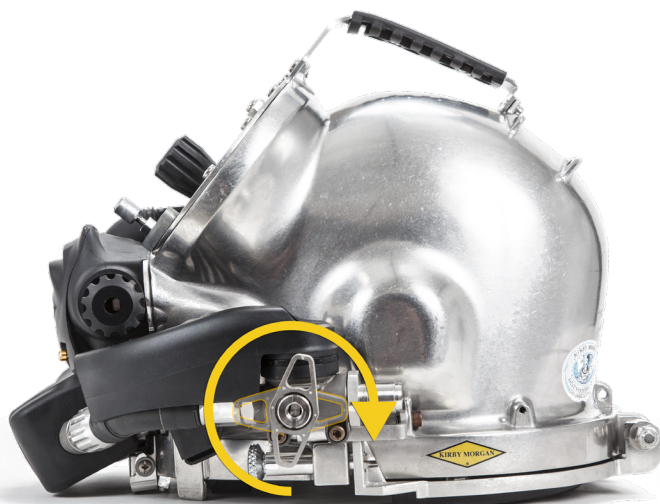

*Open Circuit/Bubbles*

ing this valve in the lowest position on the helmet the water will exit more easily.

After purging/clearing the helmet, cautiously check for additional flooding. If the helmet continues to take on water, abort the dive and return to the diving station, swimming with the water dump valve positioned at the lowest part of the helmet: with the diver's face forward and slightly tilted down. Keep the steady flow valve on slightly. This increases the air/gas pressure slightly over pressurizing inside the helmet and keeps the water out. Any incoming water is automatically purged.

**1.5.2 Return Line System Failure**

If faced with failure with the surface exhaust system and/or return line the KM Diamond should be put into the open circuit dive mode by turning the control handle, on the Surface Bypass Valve, back and to the vertical position. This will route the divers exhaust directly into the surrounding water and effectively switch the diving mode into open circuit.



**NOTE**

Full RAPID and complete handle movements must be made when turning control handle. NEVER leave control handle in a halfway position.

1. Rotate the diamond shaped control handle on the Surface Bypass Valve to the back position 90 degrees to the open circuit position.

2. Open up the Open Circuit/Overpressure Relief Valve by rotating the control knob out and away from the Diamond exhaust assembly in this

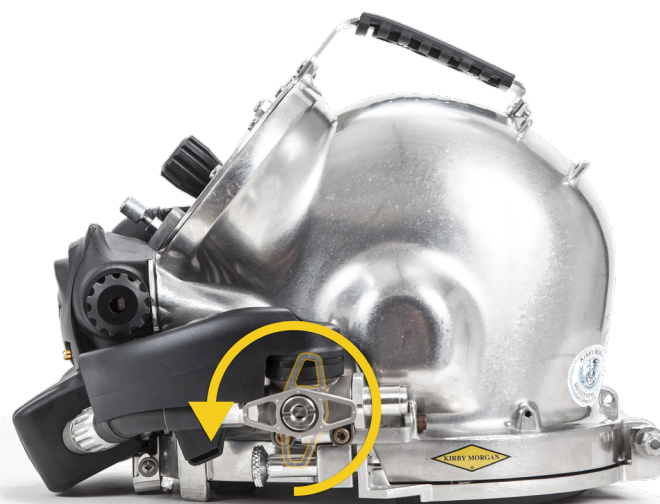

*Surface Vent/NO Bubbles*

mode; exhaust bubbles will be evident on BOTH sides of the helmet.



**HELPFUL HINT**

This will aid in improving the exhaust performance by decreasing the resistance force required to get the gas out of the helmet

**1.6 Diamond Subassemblies Removal**

**1.6.1 General Information**

The Kirby Morgan Diamond is made up of three major components. Each subassembly can be cleaned, inspected and partially serviced while secured to the helmet or completely removed with very few steps, (excluding the Diamond Regulator Pod). This allows the user or technician to exchange subassemblies with very little down time during active dive operations if needed.

**1.6.2 Tools Required**

The following tools are required to properly **REMOVE** the Kirby Morgan Diamond components from the helmet shell:

- Flat Blade Screwdriver
- Diagonal Cutters
- Needle Nose Pliers
- Allen Wrenches  
7/64 and 3/16 inch
- Open End Wrenches  
1 1/16 (2), 7/8 and 1 5/16 inch

### 1.6.3 Removing Diamond Components

Under normal conditions, it is not necessary to remove the individual Diamond components to complete post dive maintenance and inspections.

**Complete individual disassembly of the KM Diamond components should be done by a trained technician.**

When removing the Diamond components from the helmet shell it should be done in the following order:

1. Diamond Exhaust Assembly
2. Surface Bypass Valve
3. Water Purge Assembly
4. Diamond Pod

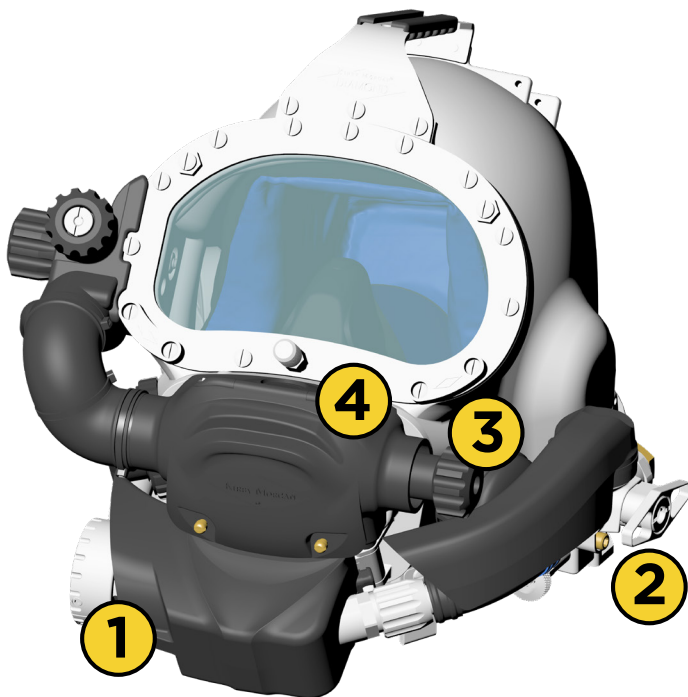

### 1.6.4 Removal of the Diamond Exhaust Assembly

#### Tools Required:

- $\frac{3}{16}$  inch Allen Wrench
- Needle nose pliers



**How to: Diamond Exhaust Removal & Installation**

<https://www.youtube.com/watch?v=VOj-m5xY32o>

1. Locate the two  $\frac{3}{16}$ " Allen head screws by opening the access cover. They are directly below the inhalation regulator on either side.



The access cover is opened by prying at the lower corners of the cover until it comes away from the bishop pins. Occasional lubrication of the holes will make this operation easy.

2. Remove the two  $\frac{3}{16}$ " Allen screws with the aid of needle nose pliers, and pull the assembly away from the helmet until it is completely clear of the large exhaust passage in the Diamond Pod.

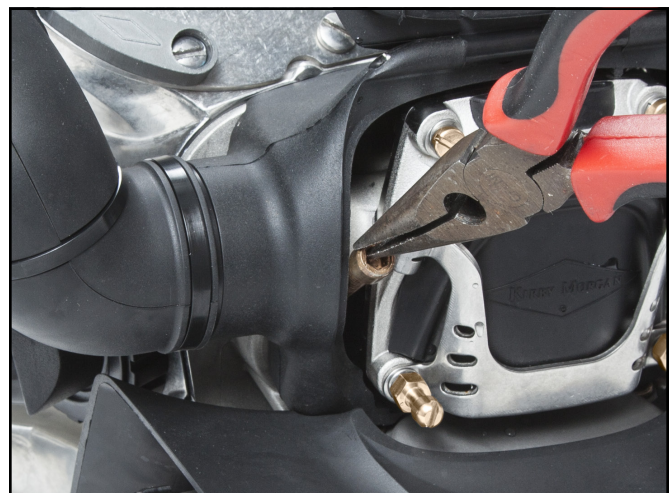
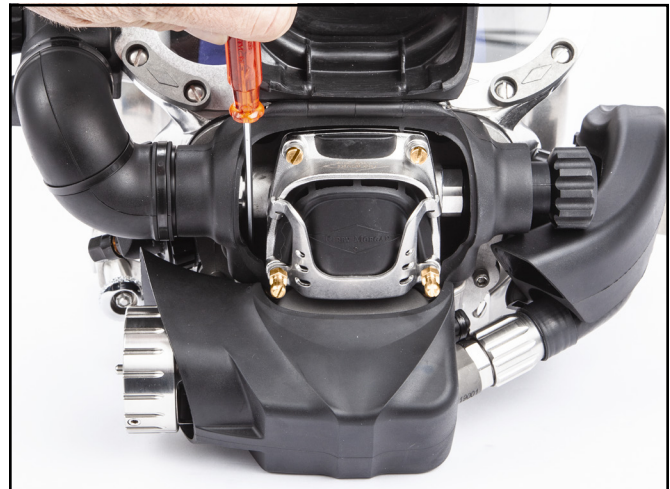

It is also possible to push up on the lower ends of the screws, found on the underside of the exhaust assembly by turning the helmet upside down and using an Allen key.



Small Allen wrench or blunt tool can be used to push screws from bottom of exhaust body.

**NOTE**

3. By hand, unscrew the Stainless Steel hose fitting from the Surface Bypass Hose.



At this point the assembly will be completely free from the system and easily handled.

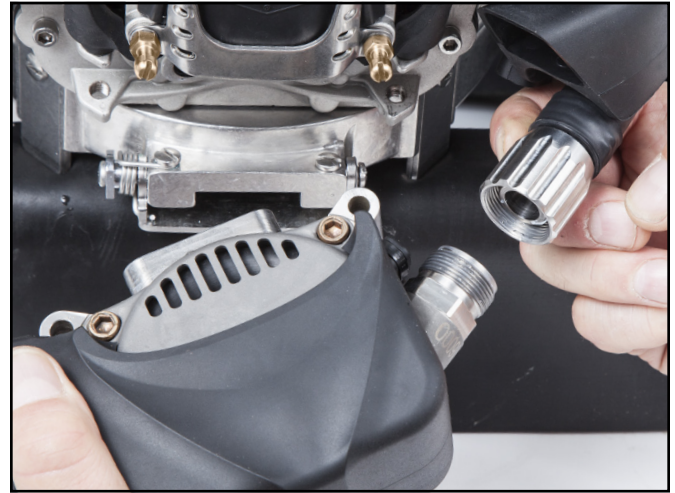

### 1.6.5 Removal of the Surface Bypass Valve

**Tools Required:**

- $\frac{3}{16}$ " Allen Wrench

1. Remove the two  $\frac{3}{16}$ " inch screws located at the base of the Surface Bypass Valve body.

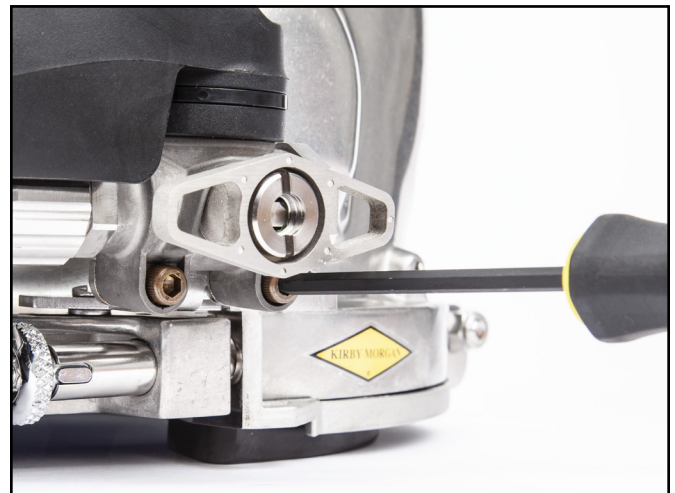



### 1.6.6 Removing the Surface Bypass Hose

Removing the Surface Bypass Hose can be done while the Surface Bypass Valve Body is still attached to the helmet if the diamond exhaust was removed. If it is only necessary to remove the bypass hose for service/ maintenance, remove the 2 Allen head screws below the bypass valve and go to the next step.

#### Tools Required:

- Diagonal Cutters



Diamond Exhaust Assembly  
MUST be removed from Pod.

#### NOTE

1. Cut the tie wrap that holds the Bypass Equalizer Tube in place and remove.
2. Unscrew the knurled nuts and remove hose.

### 1.6.7 Removing the Hose Fitting Adapter



NOTE: To remove or replace the Hose Fitting Adapter; the Control Handle MUST be in the horizontal position (Surface Vent).

#### NOTE

#### Tools Required:

- 1 ¼" Open End Wrench
- Soft Jawed Vice (*Optional*)

Removing or replacing the exhaust hose fitting is best to be done when the main body is not attached to the helmet bracket.

1. Position the control handle as shown (horizontal) to the surface vent position.



2. If using a soft jawed vice, place the mounting holes of the main body into the soft jawed vice.

3. With the 1 ¼" open end wrench as a backup, unscrew the Hose Fitting Adapter



### 1.6.7.1 Inspection of the Butterfly Valve

#### Tools Required:

- Diagonal Cutters

1. Cut tie wrap that secures the Bypass Equalizer Tube using Diagonal Cutter.

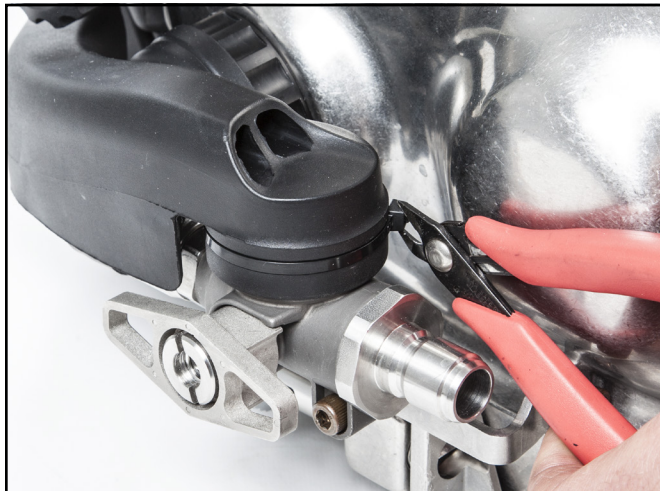

2. Remove the Bypass Equalizer Tube and inspect the exhaust valve on the Surface Bypass Valve. Ensure it is not cut, torn, deteriorated and/or folded over or under the Valve Seat Insert.

### 1.6.8 Removal of the Water Purge Assembly

**Tools Required:** None



If the Surface Bypass Valve is installed on the helmet, it is recommended to completely remove the outside Pickup Tube when removing the Water Purge Assembly. This will provide easier access.

1. With one hand inside the helmet and firmly holding the Water Purge Assembly main body, unscrew the Assembly Retainer Ring on the outside of the helmet shell.



2. Push the main body of the Water Purge Assembly into the helmet shell interior.



The entire main body can be replaced with a spare assembly that has been checked for the correct setting for the most rapid turnaround.

### 1.6.9 Removing the Diamond Main Tube

It is not necessary to remove the Diamond Main Tube from the helmet to perform field maintenance. However for scheduled overhauls the Diamond Main Tube needs to be completely removed from the helmet and disassembled.

**Tools Required:**

- ¼" Flat Blade Screwdriver
- Open End Wrenches  
7/8 (2) and 15/16 inch



Reference section "1.6.12 Removal of the Water Shrouds" on page DIAMD-21 and/or KMDSI How to Video How to remove KM Diamond Water Shrouds. Kirby Morgan Diamond® Helmet



**How to remove KM Diamond Water Shrouds. Kirby Morgan Diamond® Helmet**

<https://www.youtube.com/watch?v=1DJJHQw5QAA>

The following procedures begin once the Bent Tube has been removed. Remove the Bent Tube assembly from the helmet, per "1.3.1 Removal of the Bent Tube Assembly" on page BNT-4.



Loosen all four screws and washers on the Regulator Cover Retainer Assembly. These four screws should NOT be removed from the Regulator Cover Retainer Assembly. The cover retainer assembly is designed to retain the screws to prevent loss. Unthread the screws only enough to allow the cover assembly to separate from the main body of the regulator to expose the interior parts.

1. Remove the cover retainer assembly and diaphragm. Inspect the diaphragm for holes, tears or irregularities. If it torn or punctured it must be replaced. Inspect the interior of the regulator for foreign matter and clean if necessary.

2. Using a 7/8" wrench, remove the bent tube adapter and O-ring. Be careful not to lose the O-ring.



3. Open the access cover (if installed).

4. Carefully insert the tip of a small flat blade screwdriver into the slot at the top of the lock clip to loosen it and slide the clip away from the regulator main tube.

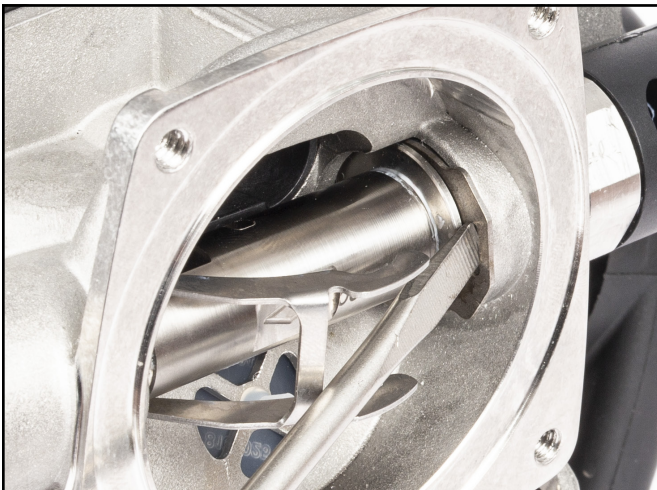

5. Using the  $\frac{15}{16}$ " open end wrench, loosen the packing nut about 1 turn. Next, while fully depressing the lever arm, grasp the flex knob and pull it straight away from the regulator body.

This will remove all of the main components of the regulator valve mechanism as a single, easy to handle unit.



**NOTE**

For guidance in disassembly of the internal components of the Diamond Main Tube see "1.5 455 Balanced Regulator Reassembly" on page 455BAL-16

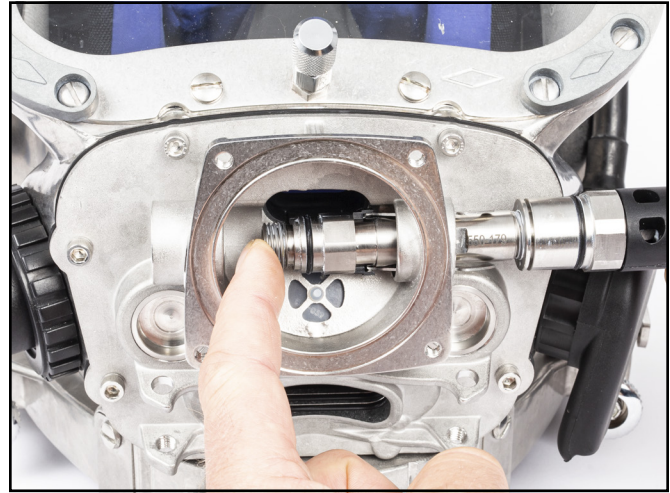

### 1.6.10 Removing the Diamond Oral Nasal Mask and Oral Nasal Insert

#### **⚠ CAUTION**

The nose block device **MUST** be removed and reinstalled when installing a new oral nasal mask due to having to clear the alignment hole found in the oral nasal insert. Simply stretching the oral nasal mask over the nose block device can cause the oral nasal mask to tear.

#### **Tools Required:**

- $\frac{7}{16}$  inch Open End Wrench
- Slip Joint Pliers and a Rag or Cloth

1. Remove the nose block device per section "1.2.1 Nose Block Assembly Removal" on page FCPRT-6.

2. Remove the microphone from the mask.

3. The oral nasal mask and insert can then be pulled off the oral nasal mounts. It is held on by a snap fit.



**NOTE**

If you want to remove the Oral Nasal Insert alone the Nose Block Assembly **MUST** be removed.

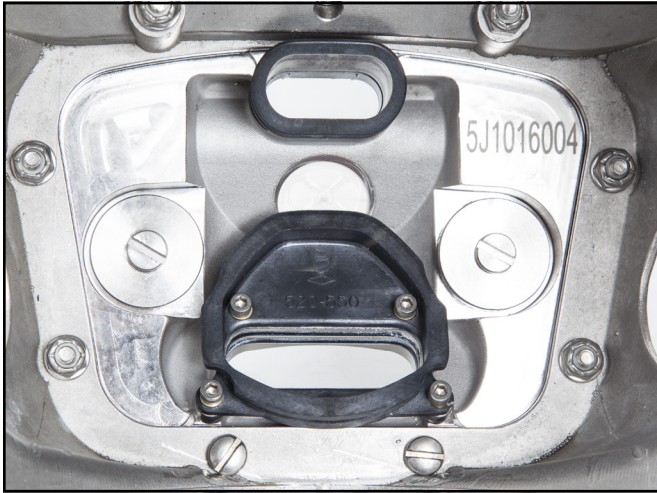

### 1.6.10.1 Removing the Oral Nasal Mount

**Tools Required:**

- 7/64" Hex Key (Ball End is Helpful)

The Diamond Oral Nasal Mask must be removed before removing the Oral Nasal Mount.

1. Use a 7/64" hex key to remove the four screws. Pay attention not to misplace the four brass washers.



2. Remove the Oral Nasal Mount.

### 1.6.10.2 Removing the Inhalation Tube

**Tools Required:**

- None

Under normal circumstance the Inhalation Tube should only be removed when a complete over-haul is done.



**NOTE**

To remove the inhalation tube the Regulator Cover/Retainer Assembly, Diaphragm and Diamond Main Tube assembly need to be removed first.

1. From the front of the Pod, use a finger to push up on the locking tab and release the inhalation tube from the mounting slot found on the Pod.
2. Push the inhalation tube away from the Pod and into the interior of the helmet until completely free of Pod.

### 1.6.10.3 Removing the Purge in the KM Diamond Pod



**NOTE**

Removing the purge valve found ONLY in the KM Diamond Pod can be done with the Pod installed onto the shell or with the Pod removed from the shell. The regulator cover assembly must to removed.

Remove the purge valve from the regulator body by hand by pulling the valve away from the Pod. Simply grasp the valve and pull to remove.



### 1.6.10.4 Removing the Hex Insert



**NOTE**

Diamond Main Tube assembly MUST be removed before removing Hex Insert. Removing the Hex Insert with the Main Tube installed may damage sealing O-rings.

**Tools Required:**

- #2 Phillips Head Screwdriver

1. Using a #2 Phillips screwdriver, remove the retaining screw.

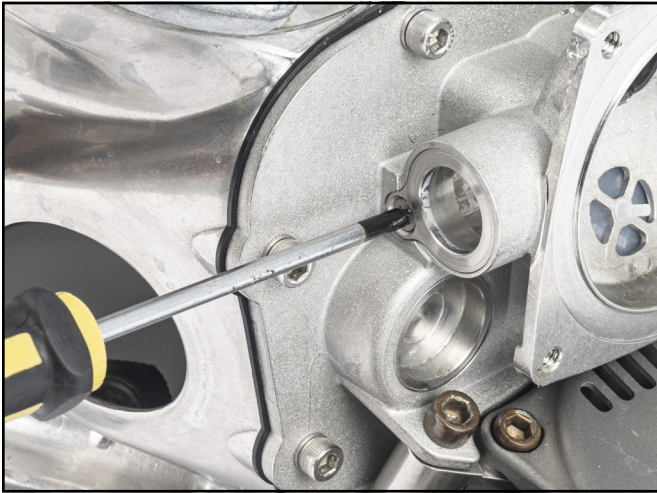

2. Pull out the hex insert and remove the O-ring.

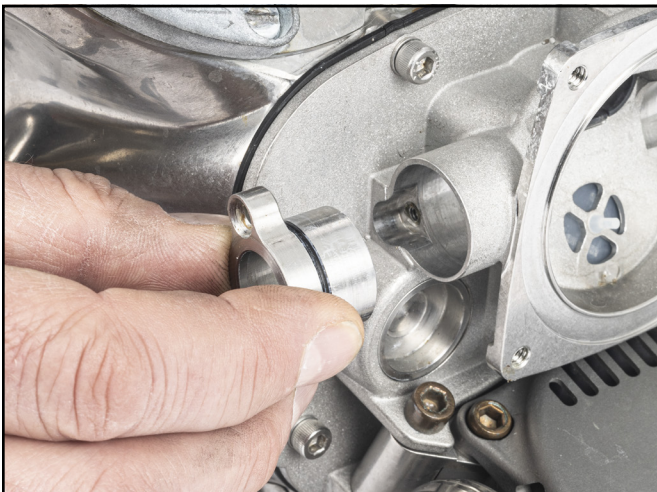

### 1.6.11 Removal of the Diamond Pod



The Pod Gasket should be removed and a new gasket installed at least every three years.

#### Tools Required:

- $\frac{3}{8}$  inch Nut Driver or  $\frac{3}{8}$  inch Open End Wrench
- Hex Keys (Ball end is helpful)  
 $\frac{7}{64}$  and  $\frac{5}{32}$  inch
- $\frac{1}{4}$ " Flat Blade Screwdriver



The Diamond Main Tube and Water Purge must be removed, prior to removing the Diamond Pod.



Six Allen screws secure the Pod to the helmet using lock nuts. Two flat heads screws secure the bottom portion of the Pod. There is a washer on each side of the Pod, the thicker washer is used on the inside of the Pod with the lock nuts, and thinner washer on the outside of the Pod. The two screws found on the bottom and inside of the Pod use the thinner washer.

The stainless steel helmets use a unique Pod system. The Pod is designed to serve as the mounting point for the regulator. The Diamond Pod is distinct as the inhalation regulator body is built into the Pod and is designed for use only with the Kirby Morgan Diamond diving system. It is also different in that the two bottom fasteners are flathead screws with no locknuts.

Prior to removing the nuts, bolts and screws that secure the Diamond Pod to the helmet shell the following components must be removed first:

- Diamond Exhaust Assembly
- Water Purge Assembly
- Diamond Main Tube



Under normal conditions, it is not necessary to remove the Pod to service the Diamond Main Tube.

1. Remove the communication module from the helmet per "1.3.3 Removal of Communications Assembly" on page COM-3.
2. Remove the chin strap by removing the screws that secure it.
3. Remove the two snap tabs adjacent to the swing catch assembly found inside the helmet.
4. Remove the bent tube assembly as per "1.3.1

Removal of the Bent Tube Assembly" on page BNT-4.

5. Remove the nose block device as per "1.2.1 Nose Block Assembly Removal" on page FCPRT-6.



The Nose block device must be removed.

6. Remove the Oral Nasal Insert and Oral Nasal Mask, see "1.6.10 Removing the Diamond Oral Nasal Mask and Oral Nasal Insert" on page DIAMD-18.

7. Remove the lower Oral Nasal Mount, see "1.6.10.1 Removing the Oral Nasal Mount" on page DIAMD-19.

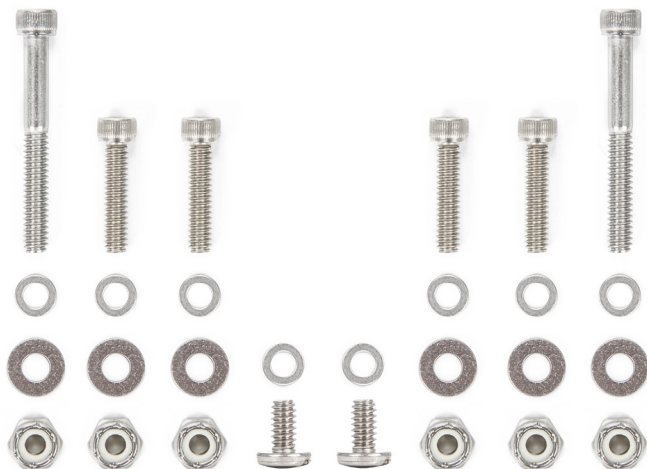

8. Remove the Diamond Main Tube per "1.6.9 Removing the Diamond Main Tube" on page DIAMD-17.

9. Loosen the screws gradually and remove lock-nuts with washers.

10. Unscrew the bottom screws and remove with washers.

11. Separate the Diamond Pod from the helmet assembly.

12. Remove the gasket for cleaning or replacement. Gasket can be reused but should be replaced at least every three years.



The lock nuts may be reused, once. It should be logged into the helmet's maintenance and repair log book. Be sure to replace them upon the next Pod gasket inspection. Failure to replace the lock nuts on the second scheduled maintenance, or attempting to reuse them more than once could result in an improper seal of the Pod, or loosening of the fasteners.

### 1.6.12 Removal of the Water Shrouds

#### Tools Required:

- Diagonal Cutters
- ¼" Flat Blade Screwdriver
- Open End Wrenches  
1½ and 7⁄8 (2) inch



**How to remove KM Diamond Water Shrouds. Kirby Morgan Diamond® Helmet**

<https://www.youtube.com/watch?v=1DJJHQw5QAA>

Some of the individual component water shrouds can be removed; others are linked to together in such a way where one Diamond component must be removed to access another. If complete removal of all the water shrouds is necessary begin with removing the Diamond Exhaust Assembly from the helmet, see "1.6.4 Removal of the Diamond Exhaust Assembly" on page DIAMD-14 for details.

The following order is recommended when removing the complete water shroud system:

1. Diamond Valve Shroud
2. Hot Water Tube A & B with adapter sleeves
3. Inhale Regulator Shroud & Access Cover
4. Side Block Shroud

**THE FOLLOWING ORDER IS RECOMMENDED WHEN REMOVING THE COMPLETE WATER SHROUD SYSTEM**

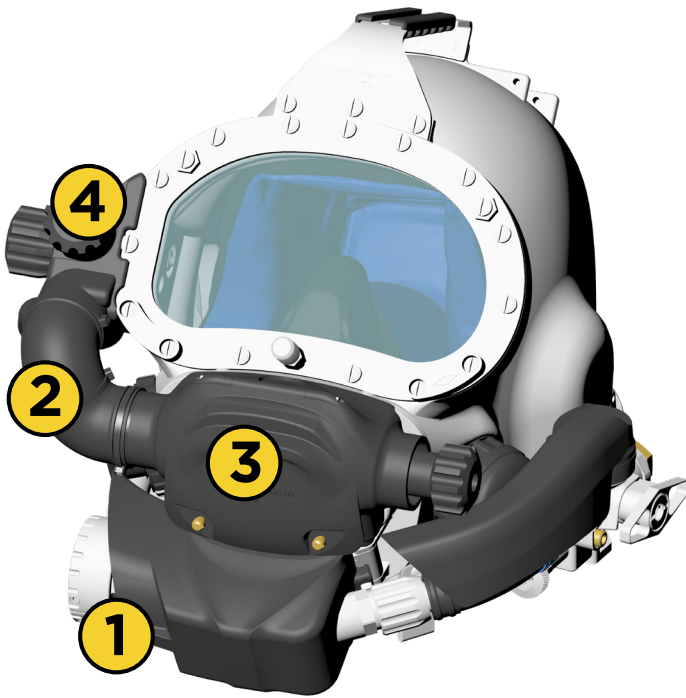

**1.6.12.1 Removal of the Diamond Valve Shroud**

First, separate the Diamond Exhaust Assembly from the helmet. See "1.6.4 Removal of the Diamond Exhaust Assembly" on page DIAMD-14

There is one tie wrap located posterior of the valve body at the opposite side of the Overpressure Relief Valve.

1. Use the diagonal cutters to cut the tie wrap and remove.



2. Pull the shroud away from the Overpressure Relief Valve.

**1.6.12.2 Removal of the Water Tube A & B with Adapter Sleeves**

Four tie wraps are used to secure the water tubes around the bent tube.

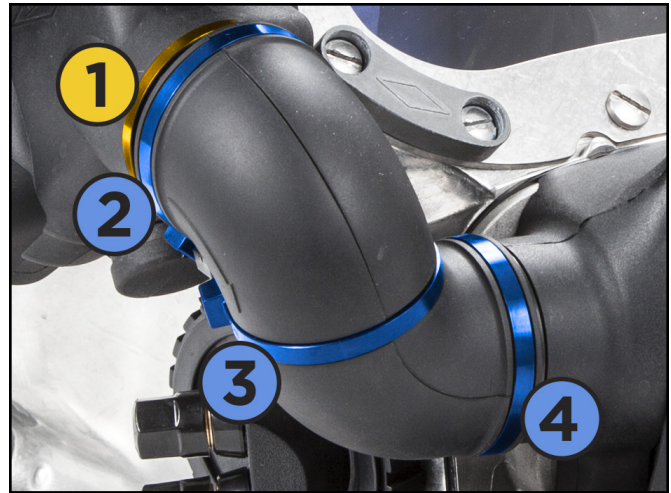

1. Cut and remove the tie wraps.
2. Remove part A and B.

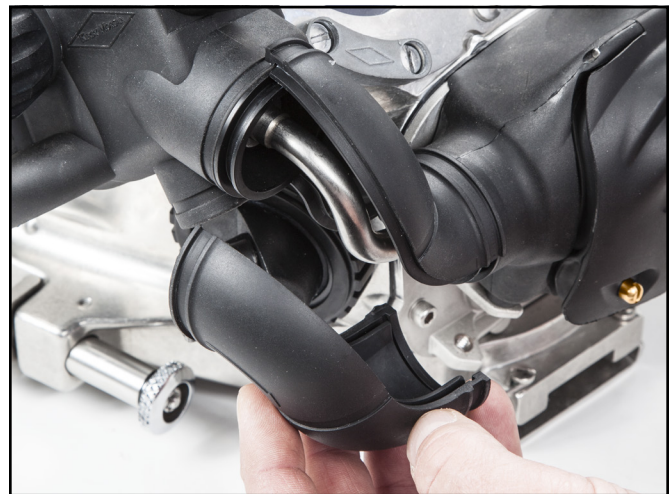

3. Slide the Adapter Sleeves out of the side block and inhalation regulator shrouds.



You will now have access to the bent tube mounting nuts and will need to remove the bent tube in order to remove the adapter sleeves and two remaining water shrouds.

See "1.3.1 Removal of the Bent Tube Assembly" on page BNT-4 for removal of the bent tube.

### 1.6.12.3 Removal of the Inhale Regulator Shroud & Access Cover

**The Bent Tube must be removed from the helmet.**



1. Remove the access cover by using a 7/64" Allen wrench or similar blunt pin type tool, to push the pin through the two shrouds.



2. Lift the access cover open, separate and remove.

3. Pull shroud away from the Pod and all fitted molded edges. Two recessed areas will be of the greatest importance.



**NOTE**

Removal begins on the inlet side opposite of the regulator adjustment knob side.

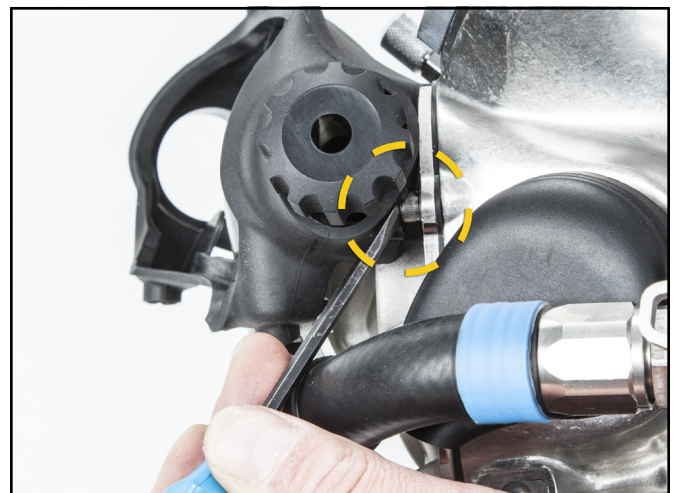

4. Pull away the shroud from the bent tube adapter until it can be lifted over and away from the inlet side of the regulator.

5. Ensure shroud is separated from mounting screws found on the Diamond Pod.



Lubricate the flex knob, if necessary, to slip the shroud over the knob.

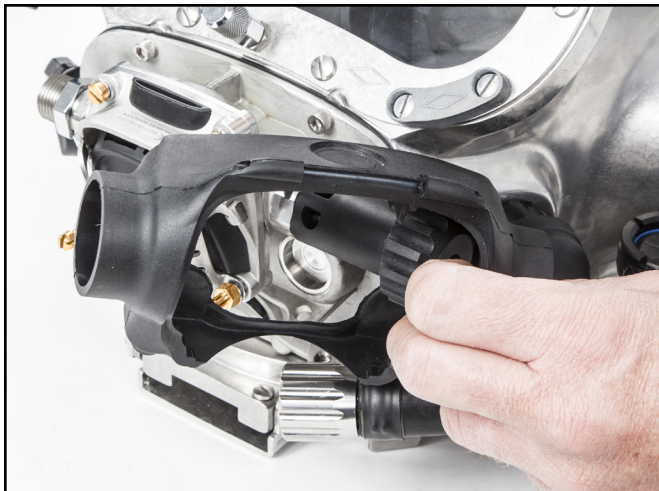
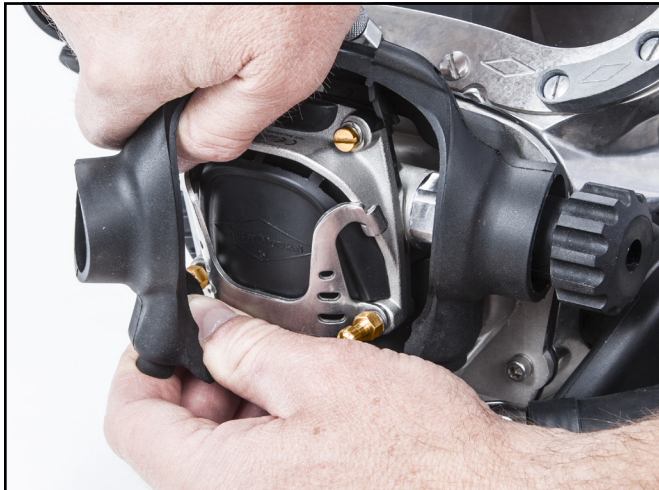

6. With a majority of the shroud lifted away from the inhale regulator body, use your hand to push the shroud completely away from regulator body. Exit path is over the flex knob and to the left side of the helmet.

### 1.6.12.4 Removal of the Side Block Shroud



Bent Tube **MUST** be REMOVED. Use the Stainless Steel Side Block module (SSB) for guidance for the required removal of side block components.

#### NOTE

1. Remove the steady flow control knob and all parts down to the seat assembly, set aside and keep separate.
2. Remove the Emergency Valve control knob and all parts down to the seat assembly, set aside and keep separate.
3. Remove the hose adapter.
4. Remove the one way valve assembly.



5. Pull the shroud off of the side block, starting from the steady flow end and working toward the back portion of the side block.



6. Remove shroud completely.

## 1.7 KM Diamond Installation

### 1.7.1 General Information

When building up the Kirby Morgan Diamond system to the helmet shell it should be done in the reverse order of the disassembly process. Assembly starts in the following order:

1. Diamond Pod
2. Diamond Main Tube
3. Water Purge Assembly
4. Surface Bypass Valve Assembly (includes hose)
5. Diamond Exhaust Assembly

#### Tools Required:

- Flat blade screwdriver
- Diagonal Cutters
- Needle Nose Pliers
- $\frac{3}{16}$  inch Allen Wrench
- Torque Wrench with Open End Attachments  
 $\frac{7}{8}$  and  $1\frac{1}{16}$  inch
- Open-end Wrenches  
 $\frac{7}{8}$  and  $1\frac{5}{16}$  inch

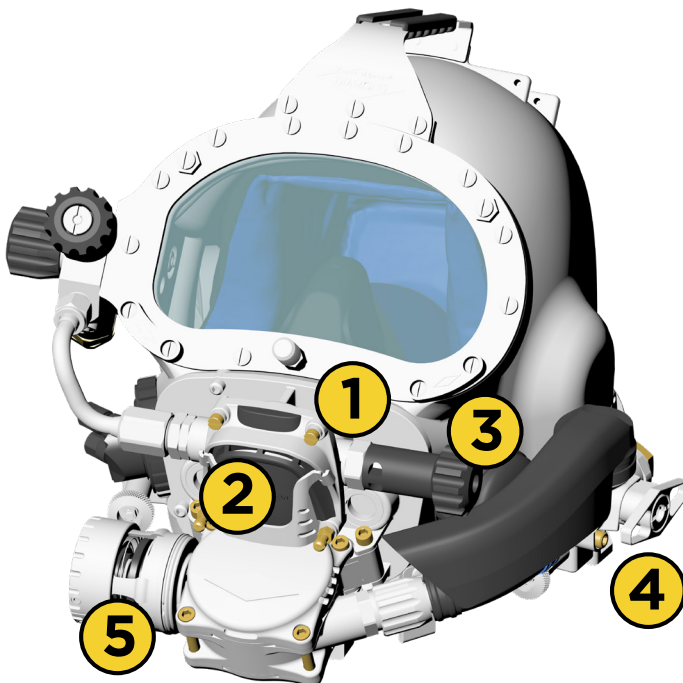

### 1.7.2 Installing the Hex Insert



#### NOTE

Diamond Main Tube assembly **MUST** be removed before removing Hex Insert. Installing the Hex Insert with the Main Tube installed may damage sealing O-rings.

#### Tools Required:

- #2 Phillips Head Screwdriver
- Loctite® 248 or Medium Strength Thread Locker Equivalent
- Christo-Lube® or Equivalent

1. Lubricate the O-ring and install it into the groove found on the Hex Insert.



2. Lightly coat the final two threads of the mounting screws with Loctite® 248 or a medium-strength thread locking compound.



3. Secure the Hex Insert to the Pod using the screw.

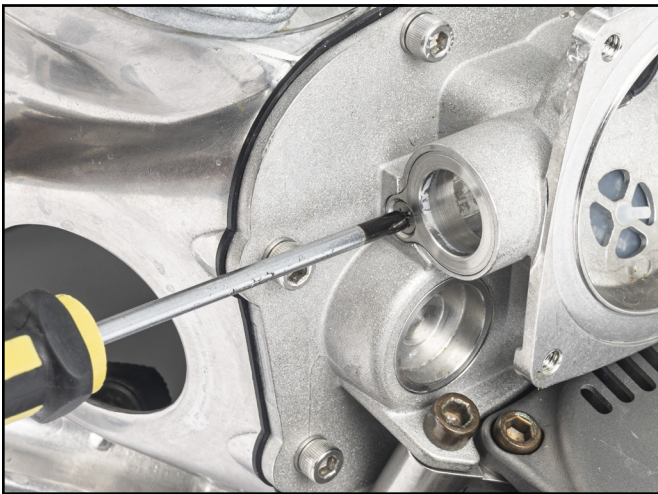
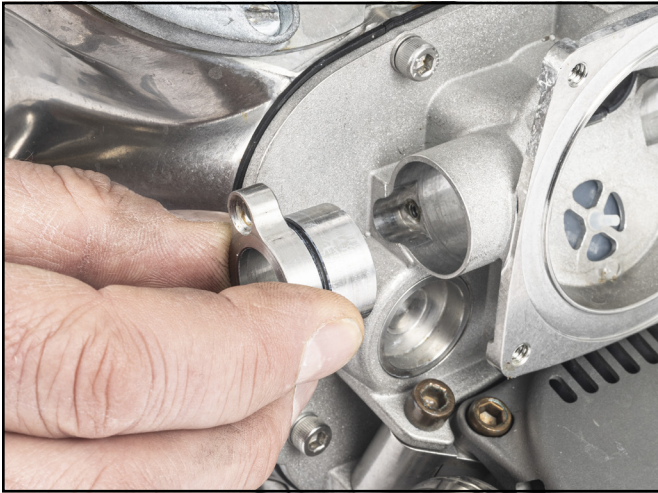

### 1.7.3 Installation of the Diamond Pod



The Diamond Pod should be installed to the helmet shell without the Oral Nasal Mount attached to the Pod. After the Diamond Pod is completely secured to the helmet shell the Oral Nasal Mount should be attached. **Oral Nasal Mount and Diamond Main Tube MUST be REMOVED before installing the Pod.**

#### Understanding the Pod System

All six mounting screws should be inserted into the Pod and **threaded** through the gasket **prior to installing** the Pod the helmet shell. The Allen screws will act as a guide when installing the Pod.

#### Tools Required:

- 3/8 inch Nut Driver or 3/8 inch Open End Wrench
- 5/32 inch Hex Key (Ball End is Helpful)
- #1 Phillips Head Screwdriver
- Torque Screwdriver
- 1/4" Flat Blade Screwdriver Attachment



**NOTE**

Six Allen screws secure the Pod to the helmet using lock nuts. Two pan head screws secure the bottom portion of the Pod. There is a washer on each side of the Pod, the thicker washer is used on the inside of the Pod with the lock nuts, and thinner washer on the outside of the Pod.

The two screws found on the bottom and inside of the Pod use the thinner washer. See "Torque Specs" module.

1. Install the gasket on the Pod. Make sure that the ridge on the gasket is properly seated in the groove in the Pod.

2. Slowly thread all the Allen screws with the thin washers through the Pod and gasket. The Allen screws will help to align the Pod and gasket to the helmet.

Remember that the two long screws are installed in the top two holes of the Pod below the face port.

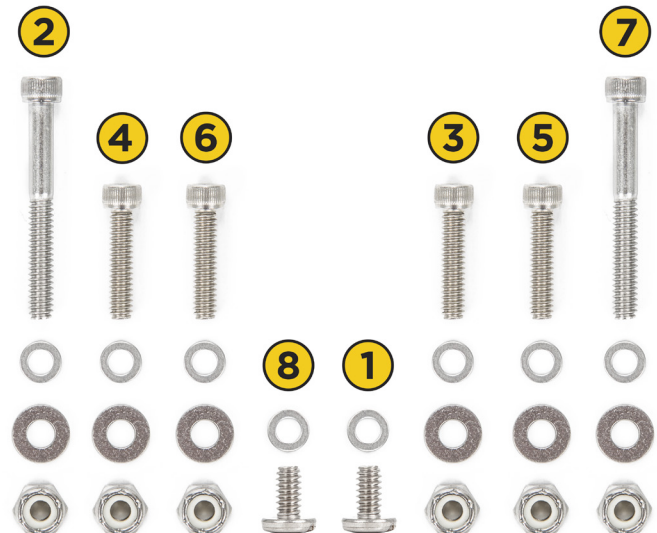

**NOTE**

Thread the screws through the gasket slowly so as not to damage the holes in the gasket with possible sharp edges of the threads. These holes have small sealing rings molded around them to seal the threads to the holes in the metal parts. It is recommended to thread the screws through the gasket rather than push it through.

3. Fit the Pod to the helmet shell so the Allen screws pass through the appropriate holes.

4. Pass the remaining (thicker) washers onto the screws and run the nuts up until hand tight.

5. Place a small amount of medium strength

thread locker onto the last two or three threads on the end of the screw. Insert bottom two flat head screws with washers (thinner) and turn them at least one full rotation to engage the threads.

6. Using the hex key and nut driver or wrench, tighten the nuts gradually in a staggered pattern, such as the one shown in the diagram. The lock nuts should be tightened to the point where the gasket can be seen just barely starting to extrude out from between the Pod and shell.

7. Complete installation by torquing the two bottom screws. See "Torque Specs" module.

**⚠ WARNING**

**All parts on Kirby Morgan helmets and masks must be adjusted to their proper torque specifications, see "Torque Specs" module for a complete listing of torque specifications for each part. Failure to adjust parts to the recommended specifications could lead to helmet failure and accidents. This could be fatal.**



### 1.7.4 Installing the Diamond Main Tube

 For guidance in assembly of the internal components of the Diamond Main Tube see "1.6 Installing the 455 Balanced Regulator onto the Helmet or BandMask" on page 455BAL-32

**Tools Required:**

- Torque Screwdriver
- 1/4" Flat Blade Screwdriver Attachment

- Torque Wrench with Open End Attachments 7/8" and 15/16 inch
- 7/8" Open End Wrench

1. Confirm the main tube O-ring has been installed and is lubricated.

2. Lubricate the internal area of the Diamond Pod where the main tube O-ring will inset. *This is important to help prevent this O-ring from possibly getting cut when it is installed.*

 Make sure the adjustment side packing nut is backed out about three turns from the main tube.

3. Depress the lever arm down and carefully install the main tube assembly into the Diamond Pod with the lever arm facing toward you so it is visible. Checking for the required gap after inserting the tube assembly is good practice to avoid re-working the installation.

Push the main tube until the threaded end of this assembly comes completely through to the opposite side of the regulator body. Make sure the HEX flat area aligns to the mating HEX in the regulator body.

 It is **ESSENTIAL** to do step 4 **FIRST** and 5 **SECOND** in this sequence.

4. Install the O-ring onto the bent tube adapter and tighten adapter to the torque specifications. See "Torque Specs" module.

A small gap should be visible between the regulator body and the adjustment packing nut on the **OUTSIDE** where the two are close to each other. If no gap is observed, back out the packing knob an additional turn and reinstall the adapter to re-check for the gap. The hex nut will have to be unscrewed a little more from the main tube to allow for correct installation.

 **NOTE**

5. Tighten the packing nut at the flex knob to the torque specifications. See "Torque Specs" module.

6. Turn in on the flex knob until an audible click is heard then out three full turns. This is typically very close to optimum adjustment.

7. Install the lock clip on the main tube, and en-

sure there is resistance felt when installing the clip.

8. Check the adjustment of the regulator. Use section "1.2.1 Test for Correct Adjustment" on page 455BAL-2. in the 455 Balanced Regulator modular manual.

### 1.7.5 Testing Demand Regulator for Correct Adjustment

To maintain optimum performance of the demand regulator on the Diamond Helmet, it should be checked for proper function and adjustment prior to the beginning of diving each diving day, in accordance with the KMDSI/Dive Lab, Inc. Daily Set Up and Functional Checklist.

Visit the Kirby Morgan® or Dive Lab websites for the latest checklists at <http://www.kirbymorgan.com/support/checklists> or <https://divelab.com/support/>.

Check the demand regulator for adjustment and proper function with the main tube installed into the Diamond Pod and supplied with a regulated breathing gas supply pressure between 135-150 psig (9.3-10.3 bar).

1. Rotate the Flex Knob in towards the helmet (clockwise) until an audible clicking can be heard with each full turn of the knob.



The adjustment knob will never bottom out or stop turning in this direction and no damage to the mechanism will occur. If you cannot hear an audible click, turn the Flex Knob out until it stops, and then turn the Flex Knob in ten full turns; this will ensure the proper starting position to begin the adjustment procedure.

2. Ensure the supply pressure is connected and properly adjusted to 135-150 psig (9.3-10.3 bar)

3. Turn on the gas supply.

4. Rotate the Flex Knob out away from the helmet (counterclockwise) slowly, three full turns.

5. Lightly depress the regulator purge cover several times and ensure the gas flow is stable.



**NOTE**

The regulator may free flow when purged if there is no backpressure (resistance) in the oral nasal mask, (e.g. the diver's face is not correctly positioned into the oral nasal mask). If the regulator free flows, simply covering the air outlet tube of the regulator inside the helmet should stop any free flow.

6. Push in gently on the cover of the regulator. There should be ¼" (6.35 mm) free travel in the cover before gas flow starts. When the cover is fully depressed, a strong surge of gas must be heard.

7. If the purge cover has NO play, or play is greater than ¼" (6 mm) BEFORE GAS flow is heard, the demand regulator requires internal adjustment.

**RECOMMENDED:** If internal adjustments are necessary it is recommended to remove the bent tube adapter and use the threads on the main tube to attach a standard second stage supply hose having a ⅝" straight thread female fitting. The female fitting will thread onto the inlet tube in place of the bent tube adapter and provide a readily available regulated L.P. gas source for testing in between adjustments.

### 1.7.6 Adjusting Diamond Main Tube

The Water Tubes A & B plus the Bent Tube and Bent Tube Adapter must be removed. The Access Cover should be opened prior to starting the below procedure.

#### Tools Required:

- Regulated air supply, 135-150 psig (9-10 bar) through standard SCUBA second stage hose
- ¼" Flat blade screwdriver
- Torque Wrench with Open End Attachment ⅞ inch
- Open End Wrenches 1⅛ and ⅞ inch

1. Turn off the air supply and bleed off the pressure and remove the supply hose to expose the adjustment nipple.



**NOTE**

If there is too much play in the lever (the purge cover travels more than ¼" when checked), the adjustable nipple will need to be turned out (counter clockwise). Too little play, the nipple will need to be turned in.

**SUGGESTED:** Whatever direction is needed, make

the adjustment in very small increments and re-check after making each adjustment. Usually  $\frac{1}{16}$ " (1.59 mm) or approximately 20 degrees turn at a time or less will suffice.

### ⚠ CAUTION

**If the adjustment nipple is screwed into the main tube too far or until it can not go further, damage to the valve seat may have occurred. This will be evident by the regulator not being able to be adjusted. This may require the replacement of the silicone valve seat. Damage to the seat may cause it to wear out faster than average and, in extreme cases, could cause the adjustable nipple to seal improperly on the seat, resulting in slight free flow.**

2. Insert a flat head screwdriver into the slot in the end of the adjustment nipple to make adjustments as necessary.

If you are unable to obtain a proper adjustment with the regulator following this procedure, or a steady flow of gas seems to be leaking, you will need to disassemble the regulator to check the condition of the lever and possibly for a damaged O-ring or inlet valve seat. Use 455 Balanced Regulator (455BAL) module for guidance found in our manuals and exploded views support tab.

#### Once the Regulator is Properly Adjusted

1. Reinstall the bent tube adapter with O-ring. Tighten the adapter in accordance with the torque specification. See "Torque Specs" module.

2. Reinstall the bent tube assembly as per "1.3.3 Installation of the Bent Tube Assembly" on page BNT-4.

3. Reinstall Water Tubes A and B with sleeves as per "1.8.13.3 Installation of the Water Tubes A & B with adapter sleeves" on page DIAMD-37.

## 1.7.7 Installation of the Water Purge Assembly

#### Tools Required:

- None

The Water Purge Assembly should be checked daily for proper installation and tightness. If the

assembly or retainer ring moves easily when checked, it should be retightened.

### ⚠ WARNING

**If the water purge assembly is not installed properly, the assembly will leak. This leads to a chance of back-flow into the helmet shell through the water purge assembly. If dirty water diving, this may result in serious illness leading to permanent injury or death.**

If necessary, remove the two mounting screws on the Surface Bypass Valve to allow better access to the water purge valve for installation and tightening.

1. Verify Pickup Tubes are properly seated to the Water Purge Main body and Retainer Ring groove by tracing the leading edge with an index finger around the circumference of the ring.



2. Install/verify the O-ring is on the Water Purge Assembly's main body; later versions of this assembly will have the O-ring slightly recessed into the housing surface.



**NOTE**

The Retainer Ring on the outside of the Auxiliary Port.



3. Position the Water Purge main body inside the helmet so the pickup tube is pointed toward the front of the helmet and the opening at the lower right Oral Nasal Mount screw.



4. Carefully and partially screw the Water Purge Assembly's main body through the auxiliary port from inside the helmet shell until resistance is felt from the Retainer Ring.

5. Screw the Retainer Ring onto the Water Purge Assembly from outside the helmet. Tighten by hand until snug against the helmet. NEVER use a wrench to tighten the ring.

## ⚠ WARNING

The Assembly Retainer Ring should never be tightened using a wrench or other tool. Tightening the retainer ring using a tool will add excessive strain to the parts and could cause damage to the module allowing the assembly to break free, resulting in flooding of the helmet which could cause injury or drowning.



The opening edge of the outside pickup tube will rub slightly on the regulator flex knob while screwing down the Retainer Ring. This is normal and will not cause damage.

6. Verify or move the position of the outer pickup tube so the opening is pointed at a 45-degree angle. Ensure the tube opening is NOT pointing straight down. Also, ensure the mounting ring does not unthread if re-positioning the tube becomes necessary, which may cause leaking.



The Retainer Ring does not need to be tightened excessively to maintain a proper seal. Excessive torque may cause part failure.

### 1.7.8 Installation of the Surface Bypass Valve

#### Tools Required

- $\frac{3}{16}$  inch Allen Wrench
- Loctite® 248 or Medium strength thread locker equivalent
- Christo-Lube® or equivalent

It is recommended installing the Surface Bypass Valve as a complete assembly with the hose attached, but not completely tightened down, as to allow the hose to slightly swivel. Before attaching the hose, lightly coat the angled surface of the fitting on the hose. The Surface Bypass Hose should be allowed to slightly swivel to allow proper mating and attachment of the Remote Exhaust Assembly.

The blue band on the hose indicates the orientation of the hose. **The side with the blue band is attached to the Surface Bypass Valve, NOT THE DIAMOND EXHAUST ASSEMBLY.**

1. Lightly coat the last two threads of the mounting screws with Loctite® 248 or medium strength thread locking compound.
2. Insert screws into the rear mounting hole and bring the Surface Bypass Valve body up to the associated bracket.
3. Use the Allen Wrench to install the backmost

screw enough where the threads catch and hold the Surface Bypass Valve body in place.



4. Insert the remaining screw into the front facing screw hole and tighten both screws completely until screws bottoms out.

### 1.7.9 Installation of the Diamond Exhaust Assembly



How to: Diamond Exhaust Removal & Installation

<https://www.youtube.com/watch?v=VOj-m5xY32o>



The Diamond Exhaust Assembly should be installed with its water shroud on. The demand/supply regulator should be completely installed with water shroud secured (if in use) prior to Exhaust regulator installation.

#### Tools Required

- $\frac{3}{16}$  inch Allen Wrench
- Needle Nose Pliers

**SUGGESTION:** Connecting the Diamond Exhaust Assembly to the Surface Bypass hose can be done with the assembly in an upside down orientation. This will put the least amount of stress on the Surface Bypass Hose when threading the knurled nut to the assembly.

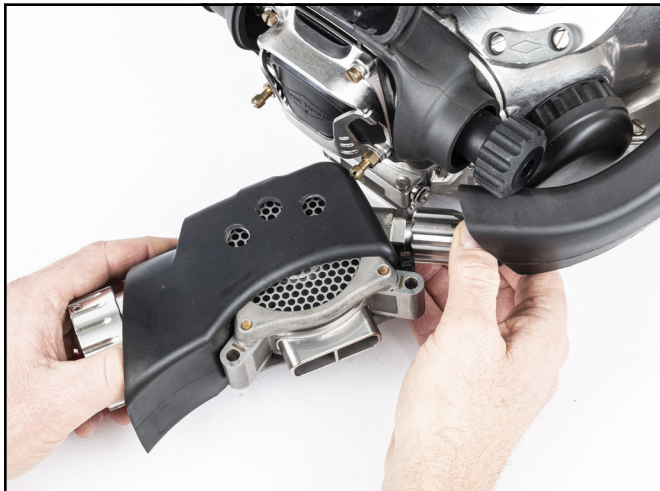

1. First connect Diamond Exhaust Assembly to the knurled nut found on the Surface Bypass Hose. Once the hose is screwed in to its stopping point be sure to unscrew the fitting 1/2 turn before fitting the assembly into the Pod.

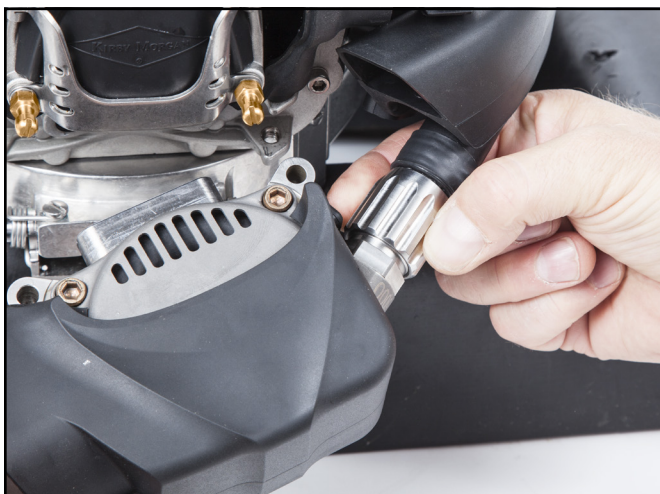

2. Fit the valve into the Pod opening. Insert the valve into the opening as straight as possible. Once the valve is fitted into the Pod opening, view the holes inside the inhale regulator shroud to verify the valve is completely pushed into its slot. The holes for the securing screws should reveal unobstructed circles.

3. Fit one of the 3/16" Allen screws into the receiving hole found just inside of the inhale regulator shroud.



**NOTE**

If the Allen screw does not fall deep into the hole it means the valve is not lined up correctly. Typically a slight wiggle of the valve will allow it to rest in the correct position or the hose end fitting may be rotated, as an adjustment, to help align the two components.

4. Use the 3/16" Allen Wrench to turn each screw in a counter clockwise direction until you can hear or feel a click. This indicates a correct threading alignment.

5. Turn the Allen Screw in a clockwise direction until firmly snug and brass screws are bottomed out.

6. Tighten the surface bypass valve hose fitting until snug.

### 1.7.10 Installing the Purge Valve in the KM Diamond Pod



**NOTE**

Removing the purge valve found ONLY in the KM Diamond Pod can be done with the Pod installed onto the shell or with the Pod removed from the shell. The regulator cover assembly must be removed.

The purge valve is installed by inserting the center stem through the receiving hole on the inside of the Pod and pressing firmly in the center of the valve to ensure correct installation.

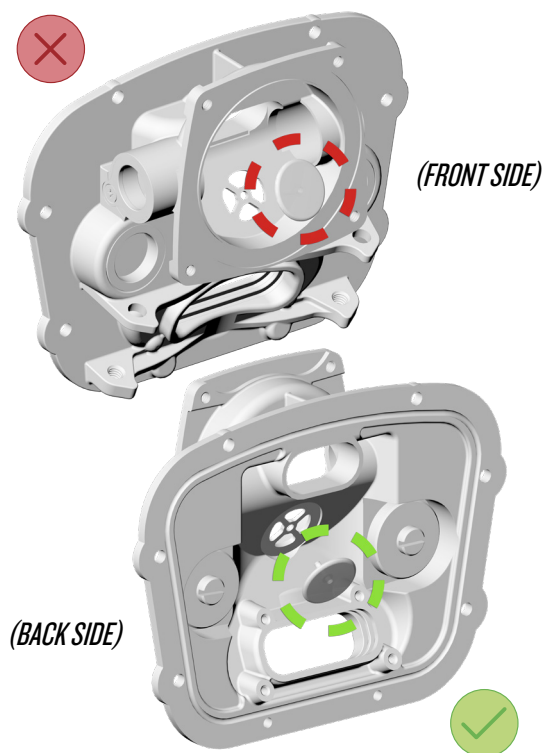



### 1.7.11 Installing the Oral Nasal Mount

**Tools Required:**

- 7/64 inch Hex Key (Ball end is helpful)
- DOWSIL™ 732 or an Equivalent RTV Sealant

1. Apply a very small amount of silicone sealant to the underside of the Oral Nasal Mount as shown. Be sure to apply sealant to the holes where the screws attach to the Pod.

<b>⚠ WARNING</b>	
	<p>Use silicone sealant in a well ventilated area. Do not breathe the fumes from uncured silicone sealant. These fumes are dangerous and can cause unconsciousness. They can also cause long term damage to body tissue. Read and follow all precautions listed on the silicone sealant tube and Material Safety Data Sheet.</p>

<b>⚠ CAUTION</b>
<p>Wear hand protection when using multi-purpose sealant. This material may irritate your skin. Read and follow the directions in the MSDS before using this material.</p>

**Correct**



**INCORRECT**



*Correct installation of the oral nasal valve is extremely important to your safety.*

2. Position mount so the four holes are lined up with the holes in the Diamond Pod as shown.
3. Place one brass washer onto each screw and tighten in a rotating pattern until snug and screws are bottomed out.
4. Wipe off any excess silicone sealant. Be sure to remove all excess silicone sealant before it sets up.

**NOTE**

It is sometimes easier to install the screws and washers into the holes of the oral nasal mount and use for easier alignment to the holes in the Pod.



### 1.7.12 Installing Inhalation Tube on the inside of the Diamond Pod

#### Tools Required:

- None

1. Position the Inhalation Tube in front of the inhalation slot with the flat side (tabs side) facing the opening of the slot and the angled end furthest away. The longest edge of the angled portion of the tube is up and the shortest length at the bottom.
2. Push the Inhalation Tube into the slot. A distinct click should be heard once tabs are engaged.
3. Test correct installation by slightly pulling back on the tube and away from the Pod. The tube

should stay secured into the Pod, but a slight amount of play can sometimes be present; this is acceptable as long as the part does not break free.

### 1.7.13 Installing the Diamond Oral Nasal Mask and Oral Nasal Insert

#### Tools Required:

- None

**NOTE**

The Nose Block Device must be removed before removing or installing the Diamond Oral Nasal Mask and Oral Nasal Insert. It is very important to install the Diamond Oral Nasal Mask correctly.

#### **CAUTION**

**The nose block device MUST be removed and reinstalled when installing a new oral nasal mask. Simply stretching the oral nasal mask over the nose block device can cause the oral nasal mask to tear.**

1. Install the Oral Nasal Valve into the Oral Nasal Mask.
2. Verify correct installation of the Oral Nasal Mask Mounts.

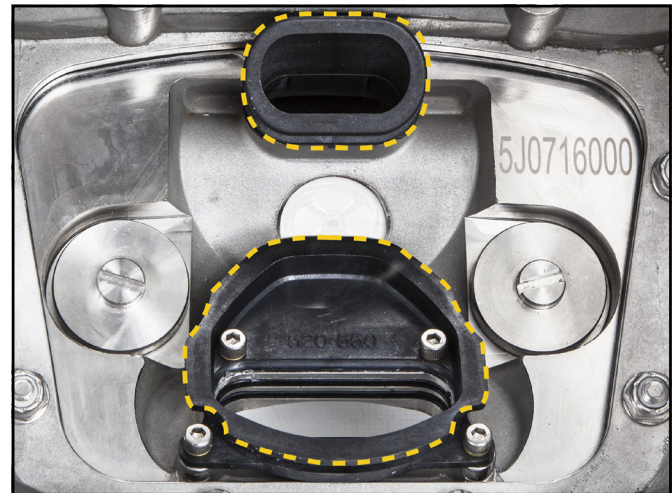

3. Stretch the upper oral nasal mounting hole onto the mounting groove in the end of the Inhalation Tube.
4. Stretch the lower oral nasal mounting hole onto the Oral Nasal Mount by stretching the top portion of the mounting hole over and into the

groove and top portion of the mounting plate, down the sides and across the bottom.

5. Work the mask into the mount grooves by pulling or pushing to release tension all around the mounts if needed.

6. Verify correct installation of the mask into the mount grooves. Use a finger to check the inside and outside of the rubber to ensure it is seated in the groove correctly.



Ensure rubber is correctly behind the screw heads and snapped onto Oral Nasal Mount.

7. Install the microphone into the Oral Nasal Mask.



8. Thread the shaft of the Nose Block Device through the hole found on the top of the Oral Nasal Insert.



The lower mounting area of the Oral Nasal Insert is pressed to fit and is held in the correct place by the snug fit of the area.



9. Thread the Nose Block Device with Oral Nasal Insert through hole found on the Oral Nasal Mask and secure per "1.2.2 Nose Block Device Replacement" on page FCPRT-7.

10. Fit the lower mounting area of the Oral Nasal Insert into the lower recessed hole of the Oral Nasal Mask and Mounting Plate and ensure leading edges are inside the Oral Nasal Mask.



## 1.8 Installation of the Water Shrouds



If there is not a need and you are not running constant water through the shrouds it is OK to remove them and operate without them on the helmet. It is not required to have the shrouds installed for proper operation.

### Tools Required:

- Tie Wraps  
P/N 520-038 (1)  
P/N 520-039 (3)  
P/N 520-049 (1)
- Torque Wrench with Open End Attachments  
1<sup>1</sup>/<sub>6</sub> and 7<sup>8</sup>/<sub>8</sub> inch
- Open Ended Wrenches  
1<sup>3</sup>/<sub>6</sub> and 7<sup>8</sup>/<sub>8</sub> inch
- Small Flat Blade Screwdriver
- Diagonal cutting pliers
- MOLYKOTE® 111 lubricant or Equivalent



SIDE BLOCK



INHALE REGULATOR



HOT WATER TUBES



PIN



ACCESS COVER



ADAPTER SLEEVES



DIAMOND VALVE SHROUD

Some of the individual water shrouds can be installed by themselves; others are linked to together in such a way where one water shroud or Diamond component must be installed prior to installing another. If complete installation of all the water shrouds is necessary begin with installing the Diamond Valve Shroud first with the Diamond Exhaust Assembly not installed into the Diamond Pod and set aside.

The following order is recommended when installing all of the water shrouds:

1. Side Block Shroud
2. Inhale Regulator Shroud & Access Cover
3. Water Tubes A & B with adapter sleeves
4. Diamond Valve Shroud

### 1.8.13.1 Installation of the Side Block Shroud

#### Tools Required:

- Torque Wrench  
1<sup>3</sup>/<sub>6</sub>" and 1" Attachments
- 1/4" Flat Blade Screwdriver

1. Remove the bailout hose fitting.
2. Remove the one way valve assembly.
3. Remove the steady flow control knob and all parts down to the seat assembly, set aside and keep separate.
4. Remove the emergency valve control knob and all parts down to the seat assembly, set aside and keep separate.
5. Remove the bent tube assembly.
6. Install the side block shroud. Starting at the bailout end, fit the shroud onto the block while progressing towards the front of the block. Make certain the shroud is positioned properly. The fit should be snug and everything should align.



7. Inspect all parts that have been removed for damages and replace as needed. Avoid mixing up any parts. Clean and reinstall all of the side block parts that were removed, **with the exception of the bent tube assembly.**

### 1.8.13.2 Inhale Regulator Shroud & Access Cover

#### Tools Required:

- MOLYKOTE® 111 lubricant or Equivalent

#### INSTALL THE SHROUD WITH THE ACCESS COVER AND PIN REMOVED

1. Lightly lubricate the opening of the regulator shroud where the adjustment knob of the regulator will pass through.

Notice the opening is surrounded by many fine

slices to allow the shroud in that area, to easily spread over the large end of the adjustment knob.

2. Starting at the flex knob end of the regulator, slip the shroud over the adjustment knob. Make sure the opening for the access door is positioned away from the helmet and at the bottom portion of the regulator when pulling the cover on. Once the adjustment knob side is on all the way, stretch the opposite end, over the bent tube adapter and onto the regulator. Once fitted, make sure the shroud is aligned to the areas of the Pod, that it needs to fit with. Pay particular attention to the Allen head screws that hold the Pod onto the helmet.

3. Align the access cover to the inhale regulator shroud. Install the pin into the right side (over pressure relieve side) of the shroud with the knurled end furthest away and the smooth end of the pin entering first.

4. Push the pin into the shrouds until it is uniformly located into the area of the regulator shroud where it will remain and terminate evenly on both ends.

### 1.8.13.3 Installation of the Water Tubes A & B with adapter sleeves

#### Tools Required:

- Torque Wrench
- 1<sup>1</sup>/<sub>16</sub>" , 7<sup>8</sup>/<sub>8</sub>" Open End Attachments
- 7<sup>8</sup>/<sub>8</sub>" Open End Wrench
- Tie wraps
  - P/N 520-039 (3)
  - P/N 520-049 (1)

1. Put the bent tube into place starting at the regulator inlet side. Start the "regulator to bent tube" mount nut onto the bent tube adaptor of the demand regulator and run it up by hand as far as it will go so the other end of the bent tube and side block line up.

2. Swing the bent tube away from the side block and put the Adapter Sleeves onto the bent tube. Ensure sleeves are in the correct orientation.



**NOTE**

Adapter sleeves remain away from shrouds until bent tube is properly installed per helmet manual guidelines. You might have to move the sleeves out of the way while securing each end of the bent tube, but they must remain on the bent tube.

3. Reinstall the bent tube assembly as per helmet manual guidelines.



**NOTE**

For final torque of the bent tube “regulator inlet side” one wrench will have to be on the outside of the Regulator Shroud and one wrench on the inside.

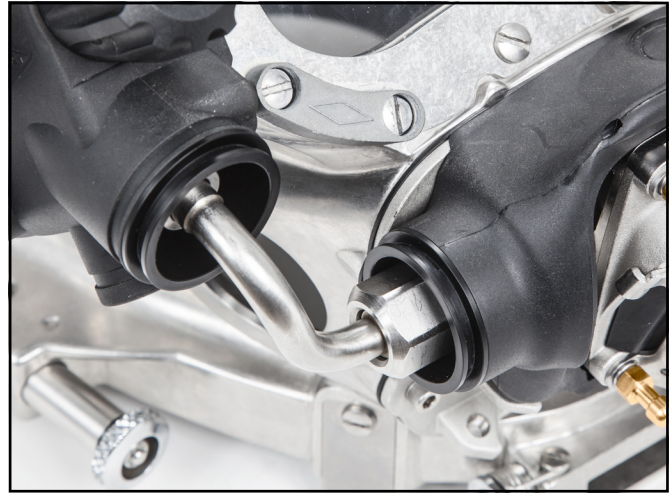

4. Lightly lubricate and align detail features of the water tubes A and B with the mating details of both sleeves, and retain the two tubes in this position using two tie wraps. Little to no gap should be evident between the two tubes. Gas flow arrow is found on the A tube and should be positioned farthest away from the helmet.

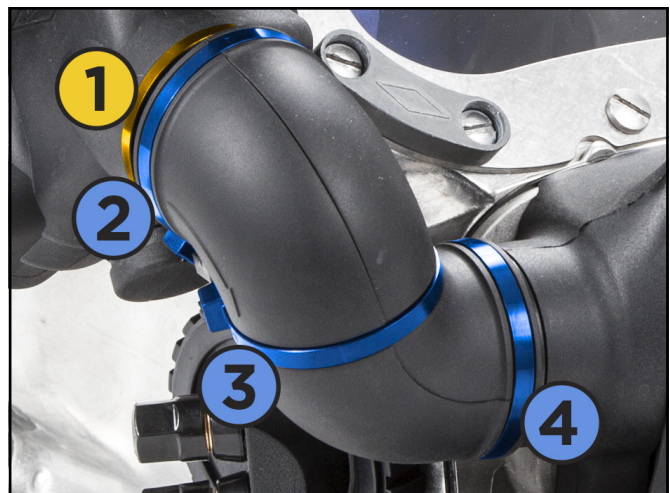

5. Using two more tie wraps, retain both the side block and regulator shrouds to the sleeves.

6. Align the access cover to the inhale regulator shroud shown, and install the pin until it is evenly located into the area of the regulator shroud where it will stay.



### 1.8.13.4 Installation of the Diamond Valve Shroud

**Tools Required:**

- Tie wrap P/N 520-038

1. With the Diamond Exhaust Valve in one hand and water shroud in the other. Fit the shroud by angling the Overpressure Relief Valve into its respective opening and continue pushing the Diamond Exhaust assembly forward until the shroud is fitted properly.



2. Once the water shroud is fitted to the Diamond Exhaust Assembly use tie wrap P/N 520-038 to secure the shroud to the valve. You will find

an extended feature on the back of the water shroud. Use this extended "Split Block" feature to secure the tie wrap onto the water shroud.



3. With the access cover open insert and install the Diamond Exhaust Assembly into the Diamond Pod. See "1.7.3 Installation of the Diamond Pod" on page DIAMD-26 for installation details.

4. Close the access cover on the water shrouds.



**NOTE**

It is helpful to lightly lubricate the Bishop Pins occasionally to make opening and closing of the access cover a little easier.

