

SuperFlow® 350 Regulator

Contents

| | | | |
|----------------|---|-----------------|---|
| SF350-1 | 1.1 SuperFlow® 350 Regulator & Exhaust System Post Dive Cleaning & Sanitizing | SF350-8 | 1.3 Regulator & Exhaust System Overhaul |
| SF350-1 | 1.1.1 Post Dive Disassembly | SF350-8 | 1.3.1 SuperFlow® 350 Demand Regulator Removal from Helmet or Mask |
| SF350-3 | 1.1.2 Sanitizing | SF350-9 | 1.4 SuperFlow® 350 Regulator Disassembly |
| SF350-3 | 1.1.3 Post Dive Reassembly | SF350-10 | 1.5 Inspection of SuperFlow® 350 Demand Regulator Parts |
| SF350-4 | 1.1.4 Special Regulator Tools for SuperFlow® 350 | SF350-12 | 1.6 Cleaning SuperFlow® 350 Regulator Parts |
| SF350-4 | 1.2 SuperFlow® 350 Demand Regulator | SF350-12 | 1.6.1 Precautions for Cleaning |
| SF350-4 | 1.2.1 General Regulator Information | SF350-13 | 1.6.2 Cleaning Instructions |
| SF350-4 | 1.2.2 SuperFlow® 350 Demand Regulator Test for Correct Adjustment, Fully Assembled | SF350-13 | 1.7 Reassembly of the SuperFlow® 350 Demand Regulator |
| SF350-5 | 1.2.3 Inspection of SuperFlow® 350 Regulator Body Interior | SF350-19 | 1.7.1 Tuning the SuperFlow® 350 Regulator |
| SF350-5 | 1.2.4 SuperFlow® 350 Demand Regulator Bias Adjustment Servicing, Demand Regulator on the Helmet | SF350-21 | 1.7.2 SuperFlow® 350 Regulator Steady Flows When Pressured Up: Special Tools Used (No P/N 525-620 KMDSI Tool Kit) |
| SF350-8 | 1.2.5 Reassembly of the SuperFlow® 350 Regulator Adjustment System | SF350-23 | 1.7.3 SuperFlow® 350 Regulator Exhaust Valve Replacement |

1.1 SuperFlow® 350 Regulator & Exhaust System Post Dive Cleaning & Sanitizing

Purpose

This procedure should be performed at completion of diving operations and/or whenever the helmet is to be used by another diver.

Tools required:

- ¼ inch Flat Blade Attachment on Torque Screwdriver
- Small Phillips Screwdriver
- Clean Wiping Rag
- Nylon Tooth Brush

- Spray Bottle with Mild Dish Soap Solution
- Spray Bottle with Antiseptic Cleaner

1.1.1 Post Dive Disassembly

1. Remove the demand regulator clamp by removing the clamp screw. Lift off the regulator cover and diaphragm.

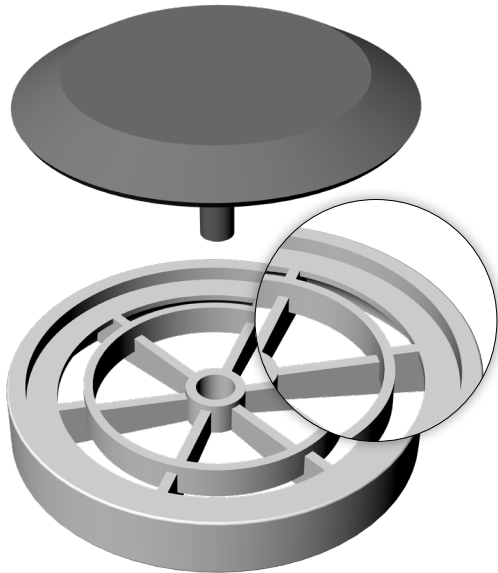

 **Correct**

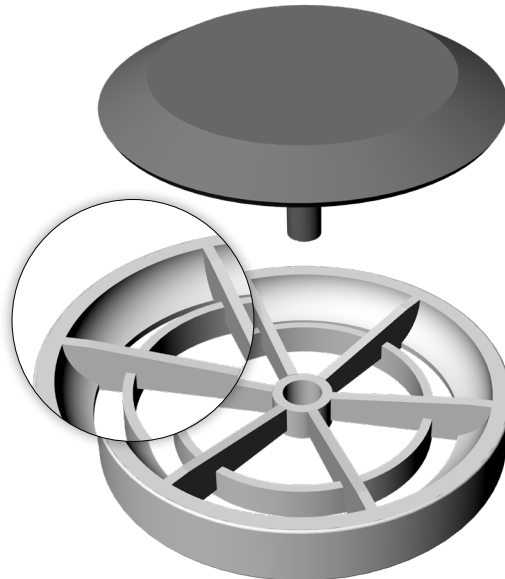

 **INCORRECT**

The exhaust valve inserts are recessed on one side to accept the exhaust valves so they sit flush in the inserts. The exhaust valves must be installed properly in the inserts or they will not seal or perform properly.

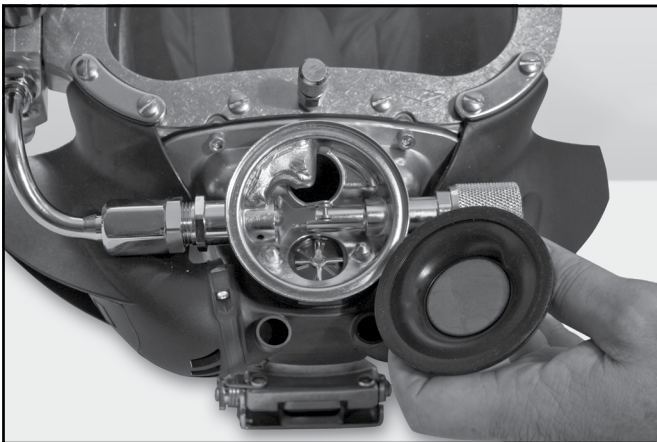

Remove the regulator cover to inspect the diaphragm.

2. Remove the nose clearing device by loosening the packing nut removing the knurled knob and sliding the shaft out through the oral nasal.
3. Remove the microphone from the oral nasal mask then remove the oral nasal mask from the helmet.
4. Remove the oral nasal valve and body.

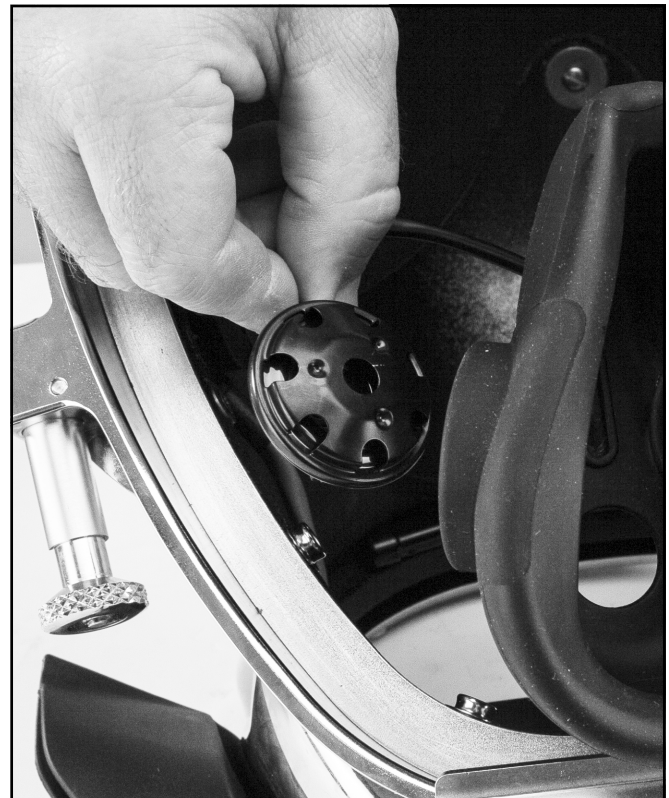

Remove the microphone so you can remove the oral nasal mask.

5. Using a small Phillips screwdriver, carefully remove the two clamps, screws & nuts then pull the whiskers away from the water dump body.

Remove the valve seats and valves. Remove the tie wrap holding the water dump components in place, then remove the valve, seat and sealing O-ring.

6. Using the soap solution, wet the exhaust valves, water dump valve, the valve seats and all surfaces exposed to the diver's exhaled breath. The water dump valve can be difficult to see so take extra care to be sure it is cleaned. Agitate surfaces with the rag and/or brush, then rinse with freshwater.

Make sure the solution flows through the rear of the regulator where the oral nasal mask attaches to the mount nut. This will help to ensure the exhaust valve in the regulator gets cleaned.

7. After cleaning with soap solution, carefully inspect everything that has been cleaned for any signs of deterioration or damage. Replace any components in question.



Inspect the exhaust valves on a regular basis.

1.1.2 Sanitizing

Sanitizing is done to minimize the spread of germs. The helmet should be sanitized daily when used by one diver, and between dives when used by multiple divers.

To maximize germ killing action, all internal surfaces that come in contact with exhaled breath need to be thoroughly wetted with the sanitizing solution and kept wet for at least ten minutes then thoroughly rinsed.

See "1.3 General Cleaning & Inspection Proce-

dures" on page GENPRE-3 for detailed sanitization instructions.

1.1.3 Post Dive Reassembly

1. Wipe clean the surfaces where the parts will fit, make sure all parts are clean, then re-install the water dump components. **Do not lubricate any of the parts. Parts must be installed dry.**

2. Reinstall the oral nasal mask onto the regulator mount nut, then lightly lubricate the nose block shaft with silicone. Install and secure by wrapping the knob with a rag, tightening with pliers while holding the padded end.

Lightly tighten the packing nut. Tighten only enough so that it cannot be loosened by hand.

3. Install the microphone into the oral nasal mask. Reinstall the oral nasal valve body and valve. Check to make sure the oral nasal valve is installed so the valve opens into the mask.

4. Reinstall both whisker valves ensuring the valves open outward away from the regulator body. They must be installed in the correct orientation.

⚠ WARNING

The exhaust valve inserts must be installed in the correct orientation in exhaust main body. If the inserts are installed backwards, the diver will be unable to exhale. This could lead to suffocation and death.

⚠ WARNING

The exhaust valves must be correctly installed in the exhaust valve inserts or they will not seal correctly. This could lead to a backflow of water into the helmet, which could expose the diver to any contaminants that are in the surrounding water. Depending on the contaminants, this could lead to serious personal injury or death.

5. Install the left and right whiskers then inspect and install the tie wraps or whisker clamps.

Place whisker clamps around the grooves in each of the two whiskers. Before doing the final tightening of the whisker clamps, make sure that the parting line on the bottom of the wings is lined

up with the parting line on the main body. For the SL 27 helmet **ONLY**, make sure that the parting line on the bottom of the whisker wings is $\frac{5}{16}$ " behind the parting line on the main body.

Properly re-align the port and starboard wings to the main body.

6. Install the diaphragm and regulator cover. Tighten the screw using a torque screwdriver. See "Torque Specs" module.

1.1.4 Special Regulator Tools for SuperFlow® 350

Five special tools should be used for maintenance and adjustment of the demand regulator assembly; the inlet valve holder, regulator adjustment wrench, socket wrench, castle wrench, and regulator mount nut socket wrench. These three wrenches make regulator adjustment much easier. The tools come in a convenient pouch with instructions, (P/N 525-620). This tool kit ships standard with every Kirby Morgan helmet equipped with the SuperFlow® 350 regulator.

1.2 SuperFlow® 350 Demand Regulator

1.2.1 General Regulator Information

While the regulator systems on all Kirby Morgan helmets are simple and highly reliable, the breathing resistance will increase if the demand regulator on your helmet is not maintained or adjusted properly. The demand regulator must receive regular maintenance to assure the best performance possible. However, in the event the demand regulator is damaged, there is always a backup supply of steady flow gas available from the defogger valve.

For the gas inlet valve and adjustment system to operate properly, the components in the demand regulator **MUST** be in good condition and **MUST** be periodically inspected and adjusted.

Five special tools, the inlet valve holder (P/N 525-616), the regulator adjustment wrench (P/N 525-611), the socket wrench (P/N 525-612), the castle wrench (P/N 525-618) and the regulator mount nut socket wrench (P/N 525-625) should be used to work on the SuperFlow® 350 regulator whenever possible.

Disassembly, assembly, and adjustment can be done without these tools, but the work is much easier if these tools are used. The above five tools

are available together along with a tool case. The "Tool Kit with Pouch" is Part #525-620. This kit is included with each new Kirby Morgan helmet that is equipped with the SuperFlow® 350 regulator.



Tool Kit with pouch - Part #525-620.

1.2.2 SuperFlow® 350 Demand Regulator Test for Correct Adjustment, Fully Assembled

To maintain optimum performance of the demand regulator, it should be checked for proper function and adjustment prior to commencement of diving each diving day, in accordance with the KMDSI Daily Set Up and Functional Checklist. See the Dive Lab website (www.divelab.com) for the latest procedures for set-up.

Check the regulator for adjustment and proper function with the assembly complete, and supplied with a breathing gas supply pressure of 135 to 150 p.s.i.g.



NOTE

135 to 150 p.s.i.g. over ambient is the standard supply pressure to be used when adjusting all KMDSI helmets and band-masks equipped with the SuperFlow® 350 regulator. See "Supply Pressure Requirements & Tables" on page SUPR-1 for recommended pressures during use.



NOTE

When storing the helmet for any length of time, ensure that the regulator adjustment knob is turned "out" fully counterclockwise to avoid stressing the bias springs and removes unnecessary pressure on the inlet valve seat. This will prolong the life of both the inlet valve, seat, and bias springs.

1. Rotate the regulator adjustment knob in, towards the regulator body.

2. Ensure the supply pressure is connected and properly adjusted to 135 to 150 p.s.i.g.
3. Turn on the gas supply.
4. Rotate the adjustment knob out counterclockwise slowly, until a slight steady flow develops.
5. Slowly rotate the adjustment knob in clockwise, until the free flow stops. Lightly depress the purge button several times and ensure the gas flow has stopped.
6. Lightly depress the purge button. There should be between $\frac{1}{16}$ " and $\frac{1}{8}$ " free travel in the button before gas flow starts. When the button is fully depressed, a strong surge of gas must be heard.
7. If the purge button travels less than $\frac{1}{16}$ " or greater than $\frac{1}{8}$ " before free flow is heard, the demand regulator requires internal adjustment, per "1.7.1 Tuning the SuperFlow® 350 Regulator" on page SF350-19.

1.2.3 Inspection of SuperFlow® 350 Regulator Body Interior

Tools required:

- $\frac{1}{4}$ inch Flat Blade Attachment on Torque Screwdriver

1. Remove the demand regulator clamp by removing the clamp screw.

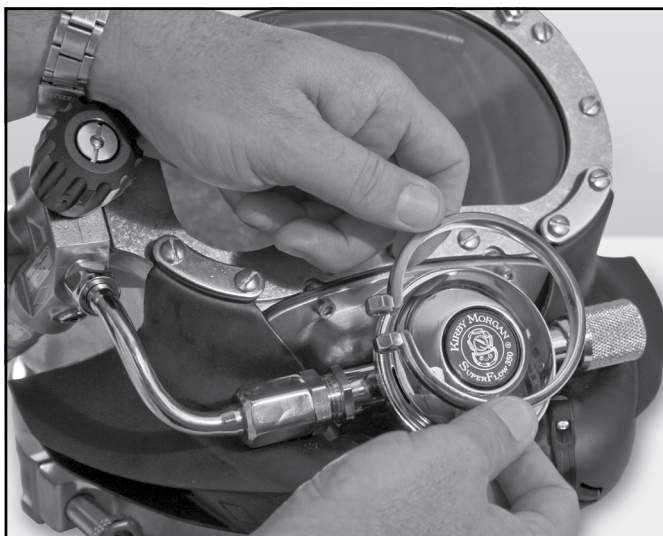

Remove the demand regulator clamp.

2. Lift off the regulator cover and diaphragm.

3. Clean the diaphragm with the soapy solution, per "1.3 General Cleaning & Inspection Procedures" on page GENPRE-3 and wipe dry. Inspect the diaphragm for holes, tears or any signs of deterioration by holding it up to a white light and stretching and pulling. Check for a good bond between the metal disc and the silicone. Replace the diaphragm if any doubt exists as to its integrity.

⚠ WARNING

Use only replacement diaphragms manufactured by Kirby Morgan. Use of other diaphragms may degrade performance and may cause increased breathing resistance. This can lead to fatigue and the inability to work at full capacity.

4. Inspect the interior of the demand regulator body for damage, corrosion and cleanliness. Clean the interior of the regulator body if necessary per "1.1 Overpressure Relief Valve Overhaul Procedures" on page OPRV-1.
5. Reinstall the diaphragm, cover, and clamp. Make sure the metal parts are clean and dry. Do not lubricate the diaphragm. Tighten the clamp screw to the recommended torque, using a torque screwdriver. See "Torque Specs" module.



NOTE

Older regulator clamps, when properly torqued, had a gap of approximately $\frac{1}{32}$ " to $\frac{1}{16}$ " between the retaining clamp surfaces when fully tightened. All current clamps when properly torqued, have little or no gap between the retaining clamp surfaces.

1.2.4 SuperFlow® 350 Demand Regulator Bias Adjustment Servicing, Demand Regulator on the Helmet



NOTE

This procedure should be used when replacing the O-ring on the adjustment shaft and/or cleaning and lubricating the shaft threads during field repairs. Start at the adjustment knob end of the regulator.

Tools required:

- $\frac{3}{4}$ inch Open-end Wrench Attachment on Torque Wrench
- $\frac{3}{32}$ inch Punch & Small Block of Wood
- Ball-Peen Hammer
- Regulator Adjustment Tool Kit, Part #525-620

- Torque Wrench

1. Unscrew the regulator adjustment knob until it stops. If the knob wobbles as you turn it, or is extremely hard to turn, the shaft is bent and needs to be replaced.

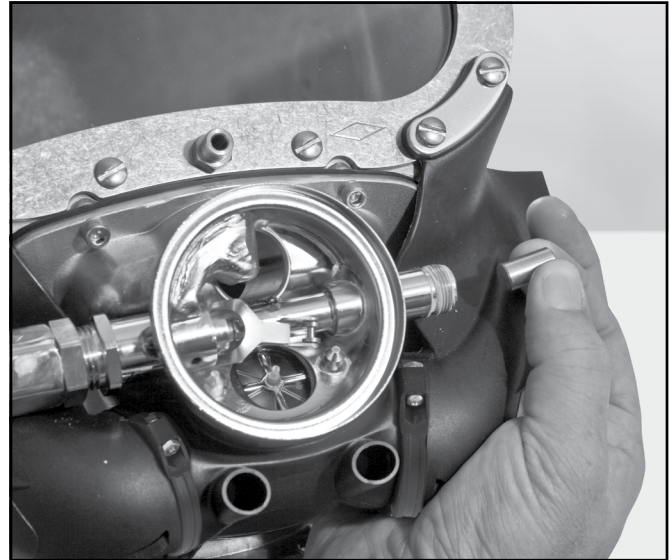

The SuperFlow® 350 regulator assembly.

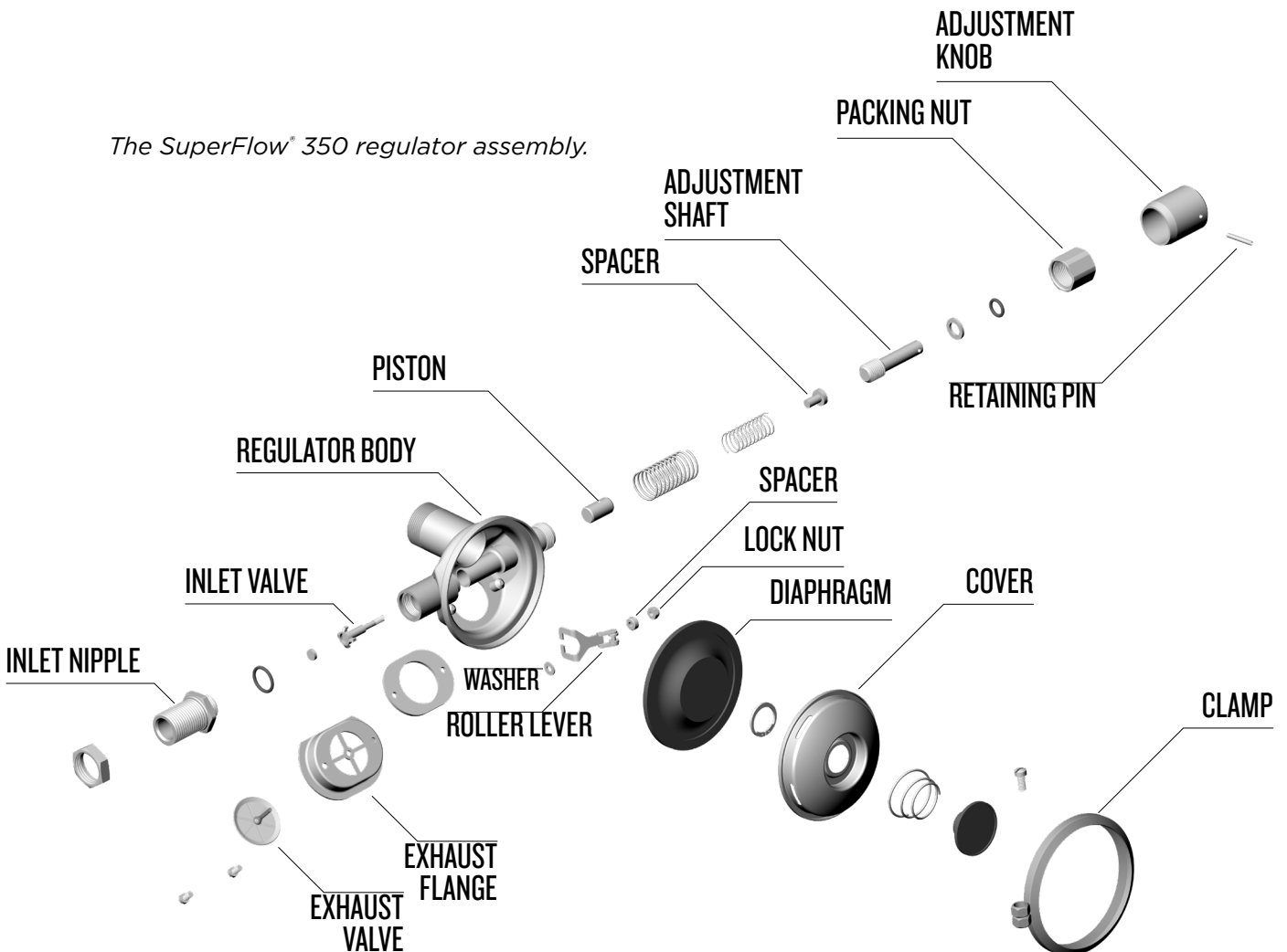

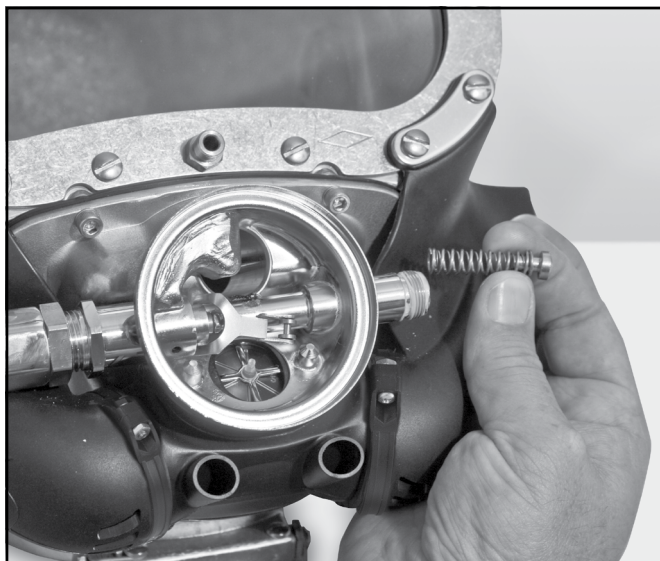

Shake out the spacer, spring set, and piston.

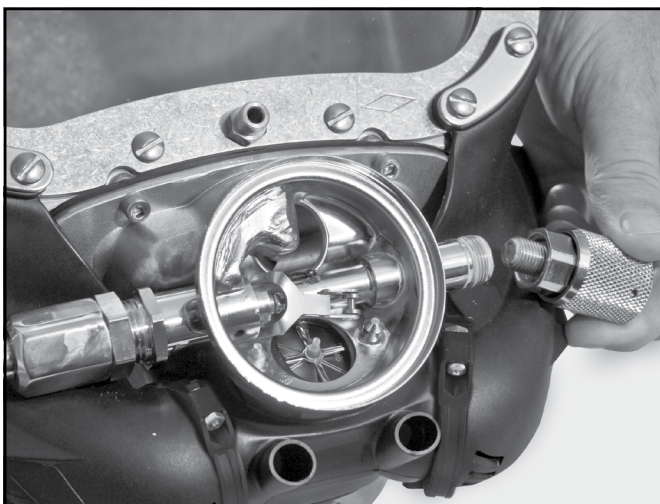

Screw the regulator adjustment knob out for removal.

2. Loosen the nut, then rotate the adjustment knob counterclockwise until the adjustment knob and the adjustment shaft are free.
3. Remove the spacer, springs, and piston. At this point the threads can be cleaned and lubricated as well as the adjustment shaft.
4. Punch out the retaining pin using a $\frac{3}{32}$ " punch. Use a block of wood with a $\frac{1}{4}$ " hole drilled through it to support the knob. Position the knob so the roll pin is over the hole. The adjustment knob can be held against the wood block allowing the roll pin to be driven into the $\frac{1}{4}$ " hole.
5. Remove the adjustment knob, the washer and O-ring.



NOTE

If the spacer and the spring set are stuck, this could indicate corrosion or possible saltwater intrusion into the adjustment tube and assembly, or that the adjustment tube is bent. The demand regulator should be removed from the helmet, cleaned and inspected, per "1.3.1 SuperFlow® 350 Demand Regulator Removal from Helmet or Mask" on page SF350-8 or for stainless steel helmets with the stainless pod, per "1.4 Removal of Regulator Alone" on page POD-4.

6. Carefully inspect all parts for corrosion, paying particular attention to threaded surfaces and the spring set. Clean and lightly lubricate parts per "1.3 General Cleaning & Inspection Procedures" on page GENPRE-3.

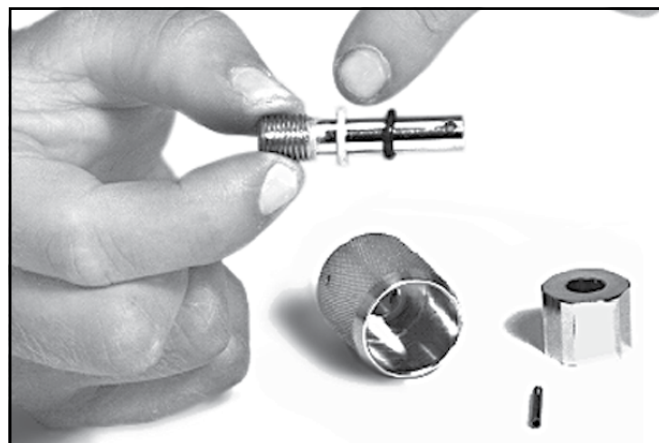

Inspect the washer and o-ring.



NOTE

Carefully inspect the adjustment shaft to ensure it is straight. Check for damaged threads. Replace the adjustment shaft and O-ring if any damage is found.

7. Replace washer.
8. Replace the O-ring.
9. Inspect the inside of the adjustment tube on the regulator body to be sure there is no corrosion and the adjustment assembly can travel freely. Ensure the alignment tube is not bent or misaligned from impact, and that the threads are clean.



NOTE

If the inside of the adjustment tube is corroded, this indicates saltwater intrusion into the adjustment tube and assembly. The demand regulator requires removal from the helmet and cleaning per "1.3.1 SuperFlow® 350 Demand Regulator Removal from Helmet or Mask" on page SF350-8 .

1.2.5 Reassembly of the SuperFlow® 350 Regulator Adjustment System

Tools required:

- $\frac{3}{4}$ inch Open-end Wrench Attachment on Torque Wrench
- Silicone grease, or oxygen compatible grease if used for oxygen service.

1. Lightly lubricate the piston and spacer and place the piston back in the regulator adjustment tube, followed by the spring set, and spacer.

2. Lightly lubricate the adjustment shaft end and threads, install the washer and the lightly lubricated O-ring on the adjustment shaft.

3. Slip the packing nut over the adjustment shaft followed by the adjustment knob.

4. Hold the shaft and rotate the knob until the pin holes line up. Use the inlet valve holder from the regulator tool kit to accurately align these holes. Using a small hammer drive the retaining pin back into place, until it is flush with the surface of the adjustment knob.

5. Screw the adjustment knob assembly clockwise back into the regulator body leaving enough packing nut exposed to place the wrench on it.



Ensure the adjustment shaft rotates smoothly.

NOTE

6. Thread the packing nut onto the regulator body and tighten with the $\frac{3}{4}$ " torque wrench. See "Torque Specs" module. Turn the knob all the way in and all the way out making sure there is no interference.

7. With the inlet valve stem depressed into the regulator body, insert the lever feet between the washer and spacer then release the pressure on the inlet valve.

1.3 Regulator & Exhaust System Overhaul

1.3.1 SuperFlow® 350 Demand Regulator Removal from Helmet or Mask

Tools required:

- Torque Wrench and 1 $\frac{3}{8}$ inch Socket

- $\frac{1}{4}$ inch Flat Blade Attachment on Torque Screwdriver
- Torque Wrench and $1\frac{1}{16}$ inch Open-end Attachment
- Torque Wrench and $1\frac{3}{16}$ inch Open-end Attachment
- Torque Wrench and $\frac{7}{8}$ inch Open-end Attachment
- $\frac{7}{8}$ inch Open-end Wrench
- And/or P/N 525-625 Regulator Mount Socket Wrench (in 525-620 Tool Kit).

1. To remove the regulator from the helmet or mask, the bent tube should be disconnected first. The bent tube assembly should be loosened at the side block and disconnected from the regulator. It may now be swiveled out of the way or completely removed.

2. Remove the whiskers from the port retainer by removing the screws. Take care not to lose the spacers, kidney plates or zinc anodes.

3. Remove the nose block device per "1.2.1 Nose Block Assembly Removal" on page FCPRT-6.

4. Remove the oral nasal mask.

5. The regulator mount nut is removed along with the sealing O-ring.



The regulator mount nut must be removed to remove the regulator.

For Quad-Valve Equipped Helmets

6. Cut the tie wrap that connects the regulator body to the Quad Valve cover.

For All Helmets

7. Now the regulator assembly can be pulled out of the helmet.

8. The center section of the exhaust whisker, named the exhaust main body has a tie wrap holding it in place. Remove the tie wrap then stretch the body off the regulator exhaust flange.

9. Older model double or single exhaust whiskers are removed similarly.

1.4 SuperFlow® 350 Regulator Disassembly

Tools required:

- ¼ inch Flat Blade Screwdriver on Torque Wrench
- ⅞ inch Open-end Attachment on Torque Wrench
- ¾ inch Open-end Attachment on Torque Wrench
- ⅜ inch Punch
- ⅞ inch Open-end Wrench

- Small Ball Peen Hammer
 - KMDSI Tool Kit Part #525-620
 - DOWSIL™ 732 or an Equivalent RTV Sealant
 - Minimum Recommended Replacement Parts for Annual Overhaul:
 - Inlet valve Soft Seat 510-580
 - Adjustment shaft O-ring 510-011
 - Adjustment Shaft Washer 520-032
 - Lock Nut 530-303
 - Diaphragm 510-553
 - Inlet Nipple O-ring 510-014
 - Exhaust valve 510-552
- Or order the “Soft Goods Kit” appropriate for your model helmet/mask.

1. Remove the screw for the regulator cover and clamp.
2. Remove the regulator cover and the diaphragm.
3. Adjustment knob removal is started by unscrewing the adjustment knob until it stops.
4. The packing nut is now exposed enough to use a wrench on it for removal. As the nut is backed off, also unscrew the knob.
5. The O-ring and washer will remain on the adjustment shaft.
6. Tilt the regulator so that the spacer, spring set, and piston fall out of the adjustment tube of the regulator.



NOTE

If the spacer and the spring set are stuck, this indicates possible corrosion or saltwater intrusion into the adjustment tube or the adjustment tube may be bent. This occurs if the helmet is dropped on the adjustment knob or the adjustment knob otherwise impacts against a rigid object. Repairs must be made by a trained KMDSI technician.

7. On the adjustment knob, drive out the retaining pin using a ⅜" punch. Use a block of wood with a ¼" hole drilled through it to support the knob. Position the knob so the retaining pin is over the hole. The adjustment knob can be held against

the wood block allowing the retaining pin to be driven into the ¼” hole.

8. Remove the inlet nipple from the regulator body. The O-ring should be replaced if a scheduled overhaul is being performed.

9. Place the castle wrench in the inlet nipple side of the demand regulator over the soft seat of the inlet valve to prevent the inlet valve from rotating.

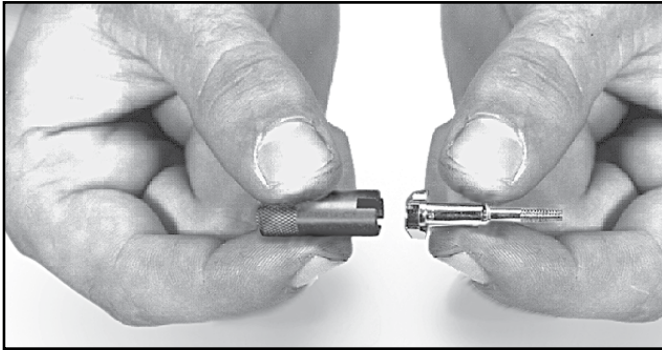

The Castle Wrench and inlet valve.

Install the socket wrench from the KMDSI Tool Kit (Part #525-620) through the adjustment tube and engage the lock nut on the inlet valve. Loosen and remove the lock nut by rotating the socket wrench counterclockwise.

CAUTION

The inlet valve adjustment nut must never be reused. Reuse of the adjustment nut will not allow the regulator to maintain proper adjustment.

10. Tilt the regulator and drop out the inlet valve and washer.

11. The spacer and lever will now fall out of the regulator body.



NOTE Ensure that the washer comes out with the other components. It may remain in place due to corrosion.

12. Remove the screws that hold the exhaust flange in position. Remove the flange and gasket from the regulator body.

13. Remove the exhaust valve from the exhaust flange prior to reassembly.

1.5 Inspection of SuperFlow® 350 Demand Regulator Parts

After the regulator has been disassembled, clean and inspect all parts. Any parts showing signs of wear, damage or deterioration should be replaced. If this is an annual overhaul KMDSI recommends replacement of the inlet valve seat, lock nut, O-ring on inlet valve, O-ring on adjustment

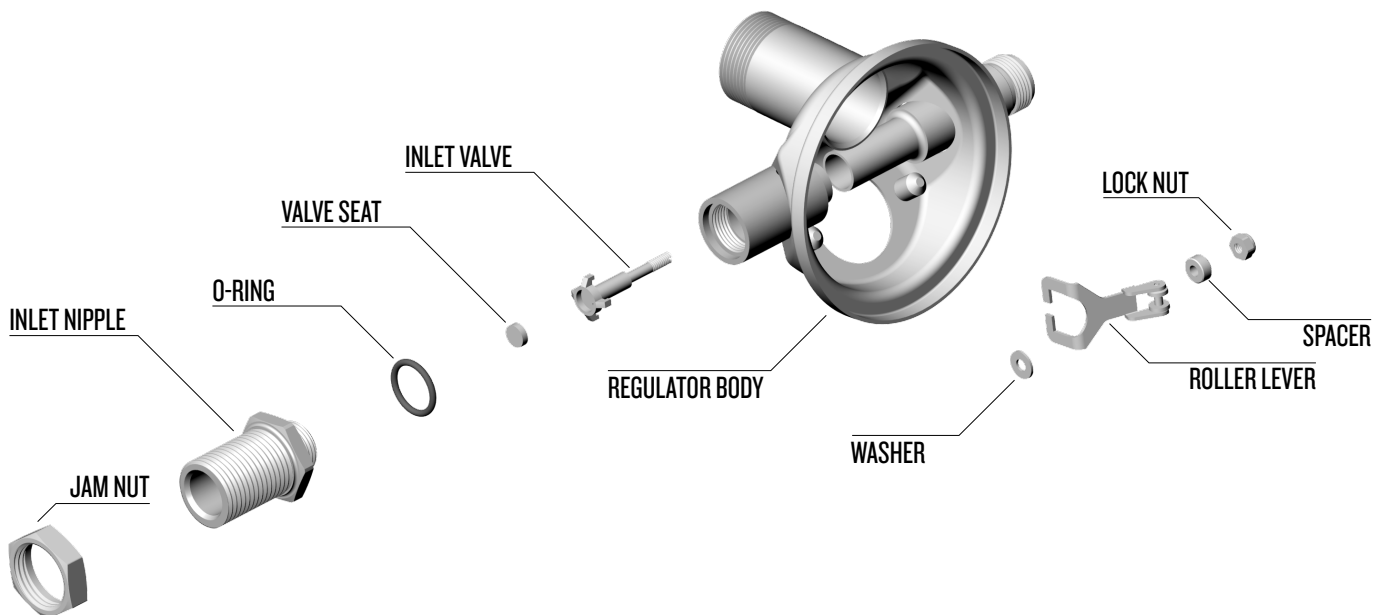

SuperFlow® 350 regulator body with roller lever assembly and inlet valve.

shaft, washer on the adjustment shaft. A rebuild kit is available for replacement parts (Part #525-309), or order the “Soft Goods Kit” appropriate for your model helmet/mask.

If any parts show any signs of damage, deterioration or any damaged threads, the part should be replaced. The lock nut must never be reused. Reuse of the lock nut will not allow the regulator to maintain proper adjustment.

1. **Exhaust valve:** Ensure the silicone exhaust valve shows no signs of damage, brittleness or any deformities. The exhaust valve should lay flat against the seat. If conducting an Annual Overhaul, the exhaust should be replaced. Ensure the seat spokes that hold the exhaust valve are smooth, even and not bent, and that the chrome plating is intact.

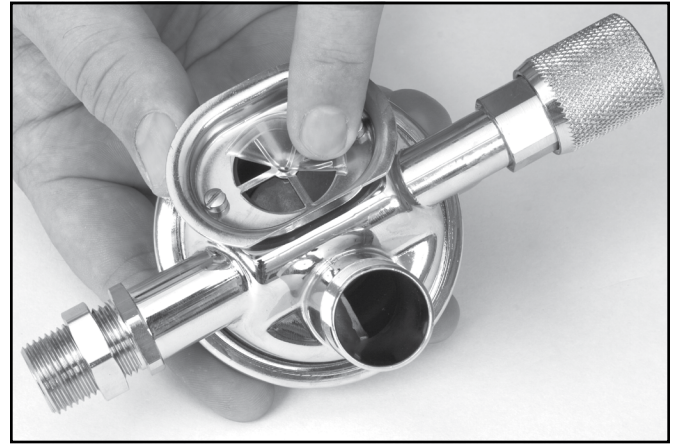

The exhaust valve must be in good condition.

Slight bends in the spokes may be removed by pressing with a thumb. The exhaust valve seating area should be free of dirt and corrosion to ensure the valve can lay flat and seal properly. NEVER lubricate the valve. Lubricating the valve will cause dirt and particles to stick to the valve and seat causing poor performance and wet breathing.

2. **Inlet valve:** Check the condition of the rubber seat for wear and/or deep grooves. If the orange silicone seat surface is stained to a dark color, this is an indication the air supply that was being used was dirty,

Adjustment end of the SuperFlow® 350 regulator.

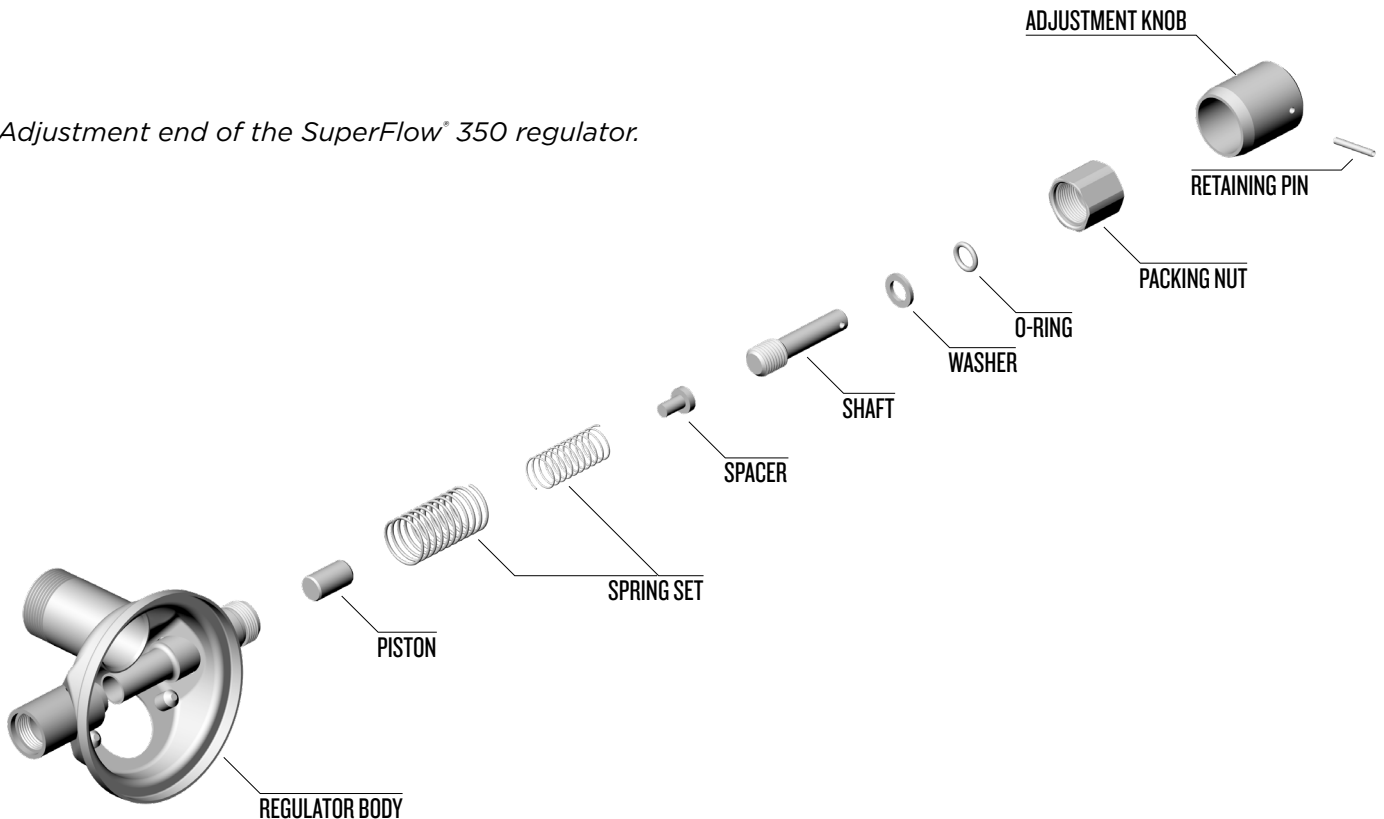

Check the condition of the inlet nipple. The inlet nipple knife-edge must be in good condition, free of nicks, chipped chrome or any damage. If the inlet nipple knife-edge has nicks or missing chrome, the inlet nipple as well as the soft seat will require replacement. During annual overhaul the inlet valve soft seat should be replaced.

3. Inlet Valve Soft Seat Replacement: To replace the soft seat use a small screwdriver or O-ring pick to pry the soft seat from the chrome plated brass valve body. Using a sewing needle or toothpick clean all old silicone sealant from the vent hole in the bottom of the cup area, and from the cupped area itself.



Replace the entire inlet valve if any chrome is missing or if the shaft is bent or thread damage is present.

4. Dab a small amount of DOWSIL™ 732 or an equivalent RTV sealant on one side of the new soft seat then press the seat into the cup area of the inlet valve assembly then using a clean cloth, wipe all excess silicone from the valve assembly. It will take approximately 12 hours for full cure of the silicone.

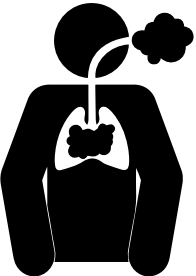

After the silicone has completely cured, double check the soft seat surface for excess cured silicone & completely clean it off.

| ⚠ WARNING | |
|---|---|
|  | <p>Use silicone sealant in a well ventilated area. Do not breathe the fumes from uncured silicone sealant. These fumes are dangerous and can cause unconsciousness. They can also cause long term damage to body tissue. Read and follow all precautions listed on the silicone sealant tube and Material Safety Data Sheet.</p> |

5. **Diaphragm:** Check to determine if rubber has separated from the metal disc. Hold the diaphragm to a bright white light, while aggressively pulling and stretching to reveal damage, deterioration, or holes.

Diaphragms showing any indication of damage should be replaced. The diaphragm should always be replaced during scheduled annual overhauls.

6. Inspect the whisker components. Replace the whisker if it shows signs of wear, aging or any damage.

For Helmets That May Be Upgradable To A Quad-Valve Exhaust

The current whiskers of the Quad Valve™ are much more rugged than the older latex double exhaust system, will give a much longer service life and provide better breathing performance at depth. Older, latex double exhaust systems should be replaced with the current Quad Valve™ exhaust system, or the Tri-Valve for the SL 27.

7. **Regulator cover:** As a general guideline dents in the regulator cover should not exceed 1/8"/3.2 mm.

Additional guidance on when a SuperFlow® 350 regulator cover may need to be replaced.

- Sharp dents may require cover replacement even if they do not exceed 1/8"/3.2 mm
- Dents that deform the regulator cover slots. These slots are critical for proper regulator function.
- Dents next to the purge button which prevent smooth operation of the button
- Old regulator covers that appear rippled and thin from long term use.
- If there's any doubt about the integrity of the cover it should be replaced.

1.6 Cleaning SuperFlow® 350 Regulator Parts

1.6.1 Precautions for Cleaning

The inlet valve of the SuperFlow® 350 requires frequent cleaning and lubrication due to the exacting tolerances of the inlet valve mechanism. Once familiar with this procedure the task can be accomplished in about 10-15 minutes. The following procedure is intended as a routine maintenance of the inlet valve mechanism. If an annual overhaul is being done, replacement of all O-rings is required.

1.6.2 Cleaning Instructions

1. If the inlet valve soft seat appears to be in good condition, clean and re-lubricate. Replace the seat if needed as per "1.5 Inspection of SuperFlow® 350 Demand Regulator Parts" on page SF350-10

2. Carefully clean all regulator components using a solution of dish soap and water, remove corrosion by soaking for 15–30 minutes in a 50% solution of vinegar and water. A tube brush should be used to clean the inside of the regulator body.

⚠ CAUTION

Use only mild soap such as hand dish washing soap. Use only a tube brush that does not have an exposed metal tip, or use an all plastic brush. A tube brush with hard metal components could scratch the plated surfaces

Use care not to scratch the metal surfaces with the end of the tube brush. Use a soft nylon brush on all other surfaces. After cleaning rinse thoroughly with warm fresh water and blow or air dry.

3. Lay out all components and carefully inspect using a bright white light, for signs of damage. Replace any components in question. Re-clean any components that show signs of contamination.

When completing a scheduled overhaul, always replace the diaphragm, exhaust valves and O-rings. Replace any and all components that show signs of wear or damage.

1.7 Reassembly of the SuperFlow® 350 Demand Regulator

Tools required:

- Cutting Pliers
- Torque Wrench
- 3/8 inch Drive Extension—Minimum 3" in Length
- 1 3/8 inch Socket or Regulator Mount Nut, P/N 525-625 (in Tool Kit included with Helmet)
- Christo-Lube® or equivalent oxygen compatible lubricant
- Torque Screwdriver with 1/4 inch Flat Blade Attachment

- Loctite® 248 or equivalent medium strength thread locker.

1. Install the exhaust flange, gasket, and screws onto the regulator body. Use Loctite® 248 or equivalent medium strength thread locker to secure the screws. Tighten the screws. See "Torque Specs" module.

⚠ WARNING

The gasket that sits between the regulator exhaust flange and regulator body must be in place. Without this gasket, the regulator will leak and drowning could result.



The gasket must be installed between the flange and regulator body.



Be sure to use Loctite® 248 or equivalent medium strength thread locker to install the screws in the regulator body.



The screws that hold the flange on the regulator body should be tightened. See "Torque Specs" module.



The exhaust valve is installed on the outside of the flange.



If the flange is tightened too much, the gasket will protrude into the exhaust valve opening and interfere with proper regulator performance.

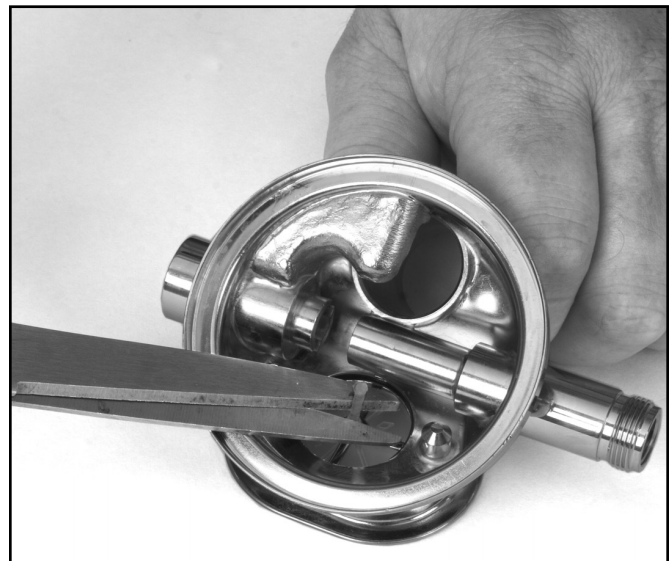

The stem of the exhaust valve that sticks into the regulator body must be trimmed.

2. Trim off any excess material from the gasket that might interfere with the operation of the exhaust valve.

3. Install the new exhaust valve into the regulator and trim off any excess stem that may interfere with the movement of the lever or inlet valve.

4. While using the castle wrench to hold the inlet valve, insert the valve into the bent tube end of the regulator body. Place the washer sharp side down, then the spacer over the end of the inlet valve stem. As an alternate procedure, the washer and spacer may be placed in the recess in the inside of the regulator body before inserting the inlet valve stem.

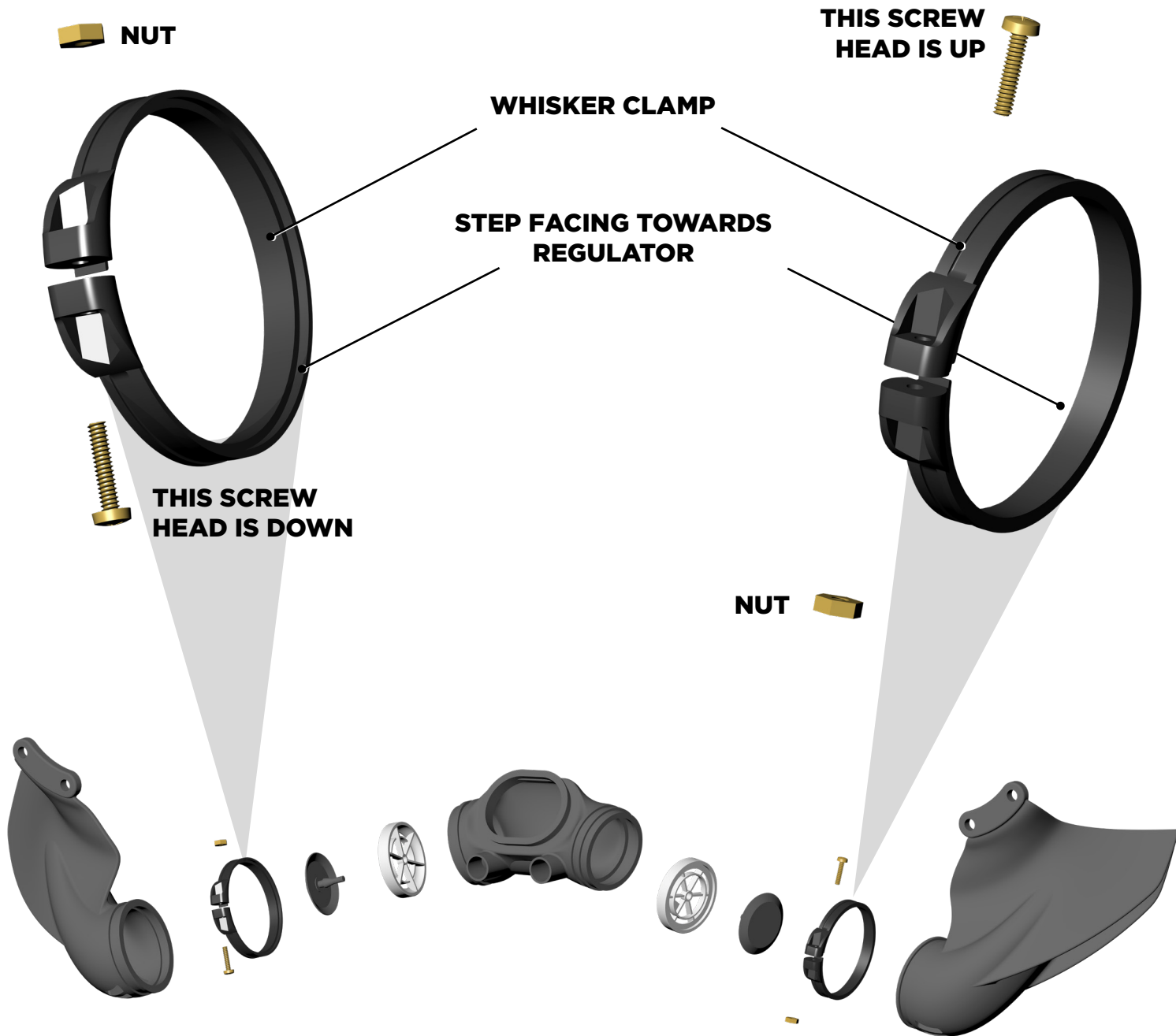

WHISKER ASSEMBLY DETAILS



Special note on whisker clamps: There is no left or right whisker clamp. Both clamps are identical.

If the clamps are not oriented correctly, it will be very difficult to tighten the screws that secure them. There is also a strong possibility that the clamp will come off the whisker, reducing the effectiveness of the exhaust system in keeping the breathing system dry.

⚠ WARNING

If the whisker clamps are not installed properly, the exhaust valves will leak. This leads to a chance of backflow into the regulator through the exhaust valve. If contaminated water diving, this is may result in serious illness leading to permanent injury or death.

⚠ CAUTION

Be sure the washer and spacer installed on the inlet valve shaft are installed in the correct sequence. If they are not, the regulator will not perform properly.

5. Using the socket wrench from the tool kit, run the lock nut onto the inlet valve stem approximately 1 ½ to 2 turns, leaving enough slack to allow installation of the lever. With the inlet valve pressed in, the washer and spacer must be loose on the inlet valve stem so the lever can be installed.

6. Check the roller lever. The lever legs **MUST** be parallel to each other and free of any nicks or burrs. Check them with a straight edge and align them if necessary by carefully bending them with pliers.

7. With the inlet valve stem depressed into the regulator body, insert the feet of the roller lever between the washer and spacer, then release the pressure on the inlet valve.

8. Hold the inlet valve with the castle wrench so that it cannot rotate, tighten the nut until three threads are visible past the nut. This will be acceptable for initial set up.

9. While holding the lever down, install the inlet nipple with its O-ring on, into the regulator body. Using the torque wrench, tighten the inlet nipple. See "Torque Specs" module. Make sure the jam nut is completely threaded on to the inlet nipple.

10. Lightly lubricate the piston and spacer. Install the piston, spring set and spacer into the adjustment tube of the regulator body, sequence as shown in the blow-apart drawing.

11. For the adjustment shaft, lightly lubricate the new O-ring then install it and the new washer onto the shaft.

12. Slide the packing nut onto the adjustment shaft, then slip the knob onto the end of the shaft. Hold the shaft and rotate the knob until the pinholes line up. Use the inlet valve holder - the "L" shaped tool (or a ⅜" punch), from the regulator tool kit to accurately align these holes.

13. Install the retaining pin by tapping it in with a small hammer until it is flush with the outer surface of the knob.



Install the retaining pin into the adjustment knob.

14. Lightly lubricate the end of the shaft and the threads with the appropriate lubricant. Thread the adjustment shaft clockwise, using the adjustment knob, into the regulator tube until the packing nut can be started.

Back out the adjustment knob once the packing nut is engaged on the demand regulator body to access the packing nut with the torque wrench. Using a torque wrench, tighten the packing nut. See "Torque Specs" module.

15. Rotate the adjustment knob in i.e., clockwise, several turns, then recheck the torque one more time. Ensure the adjustment shaft rotates smoothly and there is no binding.

For Quad-Valve Exhaust

16. Stretch the Quad-Valve main exhaust body onto the exhaust flange of the regulator. Install a tie wrap and tighten. Cut and discard protruding end of tie wrap. Rotate as needed so the port and starboard whiskers can be installed.

For Tri-Valve Exhaust

17. Stretch the Tri-Valve® main exhaust body onto the exhaust flange of the regulator. Rotate as needed so the port and starboard whiskers can be installed.

For Older Double Exhaust Or Single Exhaust

18. For the older double exhaust or single exhaust, stretch the exhaust whisker onto the exhaust flange of the regulator. Fasten the double exhaust to the regulator with a tie wrap and tighten.

⚠ WARNING

The exhaust valves must be correctly installed in the exhaust valve inserts or they will not seal correctly. This could lead to a backflow of water into the helmet, which could expose the diver to contaminants in the water. Depending upon the properties of the contaminants, this could lead to serious personal injury or death.

For All Helmets

Inspect the whisker exhaust valve inserts for damage and contamination. Install new valves ensuring they are installed onto the correct side of the inserts.

19. Install the inserts with exhaust valves into the Quad-Valve main exhaust body. Refer to the notation or marks made when the parts were disassembled.

⚠ WARNING

The exhaust valve inserts must be installed in the correct orientation in the Tri/Quad Valve exhaust main body. If the inserts are installed backwards, the diver will be unable to exhale. This could lead to suffocation and death.

For Helmets Equipped With Tie-Wraps

20. Install the left and right whiskers then inspect and install the tie-wraps.

For Helmets Equipped With Whisker Clamps

21. Install the left and right whiskers then inspect and install the whisker clamps.

Place whisker clamps around the grooves on each of the two whiskers. Before doing the final tightening of the whisker clamps, make sure that the parting line on the bottom of the wings is lined up with the parting line on the main body. For the SL 27 helmet **ONLY**, make sure that the parting line on the bottom of the whisker wings is $\frac{5}{16}$ " behind the parting line on the main body.



Note the step on the inside of the whisker clamps. These must be oriented in the correct position to retain the whisker properly.

Properly re-align the port and starboard wings to the main body.



The port and starboard whiskers should align with the whisker covering the main body so that the parting lines are in alignment (except in the SL 27 helmet, where the parting lines on the bottom of the whiskers should be $\frac{5}{16}$ " behind the mold line on the main body). You can also make marks on the whiskers with a felt tip pen.

For All Helmets

22. Pre install a tie wrap as shown onto the whisker main body. This will make installation much easier and ensure a good seal.



Pre-install the tie wrap.

For Helmets Equipped With The Stainless Steel Quad-Valve Pod

23. Insert the regulator into the pod and align by stretching the main Quad Valve exhaust body onto the quad exhaust extension on the pod.



Insert the regulator into the pod.

Carefully tighten the tie wrap, making sure it is completely in the groove. Trim the tie wrap as close as possible. Check for good fit.

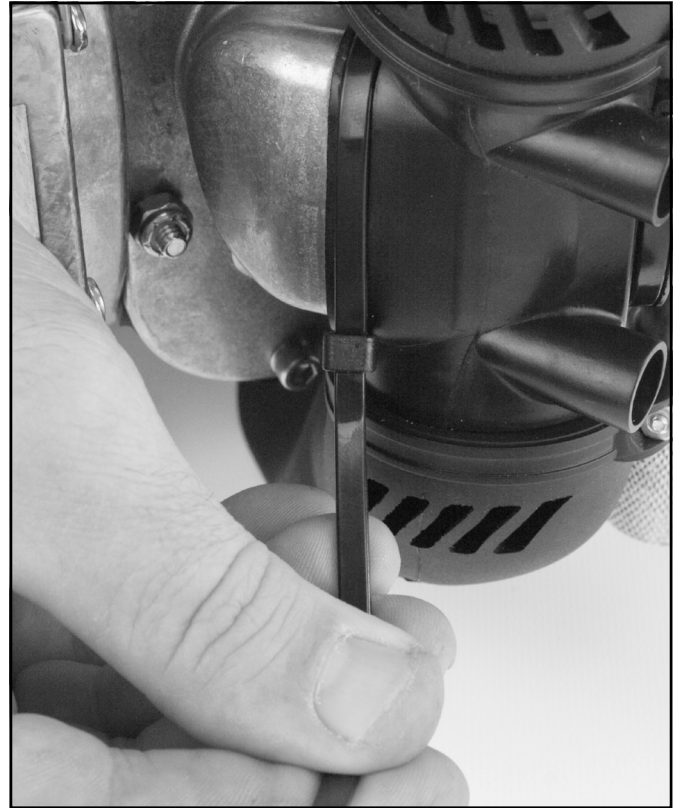

Carefully tighten tie wrap.

For All Helmets

24. Inspect the regulator mount nut for contaminants and damage. Use a tooth brush to clean threads as needed. Lightly lubricate the regulator mounting tube threads and the sealing O-ring with food grade silicone grease such as Molykote® 111 or equivalent.





25. Install the sealing O-ring, then thread the regulator mount nut onto the regulator, finger tight ONLY.

26. Carefully inspect the bent tube for damage and contaminants. The bent tube must be free of dents and compressions deeper than $\frac{1}{8}$ " and should not have deep scratches or severe corrosion. Replace the bent tube if questionable. Install the bent tube assembly finger tight before final tightening of the regulator mount nut.



If this maintenance is during an annual overhaul, replace the Teflon® ring at the side block end of the bent tube and the O-ring at the demand regulator inlet side of the bent tube.

Lightly lubricate the O-ring on the bent tube assembly. Slide the O-ring end of the bent tube assembly into the regulator inlet nipple until the side block end is aligned with the threads for the bent tube mount nut. Rotating clockwise, thread the large nut on the bent tube assembly onto the inlet nipple 1 to 2 threads.

Ensure that the Teflon® ring is in place and engage the bent tube nut to the side block fully until it is hand tight. You may need to gently rock the regulator body and/or the bent tube to fully engage the side block nut.

Next, fully engage (clockwise) the large nut on the bent tube into the regulator inlet until hand tight. This will ensure the nut is bottomed on the shoulder of the bent tube. Do not tighten further.

Loosen the jam nut on the regulator inlet (counterclockwise), and engage the jam nut fully to the large nut on the bent tube. Using a torque wrench and an $\frac{7}{8}$ " open end wrench hold the large nut

on the regulator end of the bent tube and tighten the jam nut. See "Torque Specs" module.

27. Ensuring the O-ring is in place, use a torque wrench with a $1\frac{3}{8}$ " socket and an extension to tighten the regulator mount nut. See "Torque Specs" module. Next, using a torque wrench with an $1\frac{1}{16}$ " adapter, torque the bent tube nut to the side block. See "Torque Specs" module.

28. Attach the whisker to each side of the face port retainer using the screws, zinc anodes or kidney plates and spacers, **Stainless steel shells ONLY** use Loctite® 248 or equivalent medium strength thread locker. Using a torque wrench with a flat blade screwdriver adapter, carefully torque these screws. See "Torque Specs" module.



The Quad Valve must be properly connected to the regulator and the quad exhaust extension on the pod.

29. Adjust the regulator following instructions in "1.7.1 Tuning the SuperFlow® 350 Regulator" on page SF350-19.

30. Make sure the diaphragm & mating surfaces are clean and free of lubricant.

31. Install the diaphragm, cover and screw. After all adjustments and fine tuning are complete, tighten the screw using a torque screwdriver. See "Torque Specs" module.

1.7.1 Tuning the SuperFlow® 350 Regulator

1. If not already done, remove the clamp, cover and diaphragm.

2. Screw the adjustment knob (clockwise) all the way in, towards the regulator body.

3. Pressurize the regulator to between 135–150 p.s.i.g. of supply pressure.

4. Screw the adjustment knob out (counterclockwise) until the regulator starts to free flow, then screw the adjustment knob in (clockwise) until the free-flow just stops. Depress the lever several times to ensure the free-flow has stopped.

If the free flow does not stop, the lock nut is too tight. If the roller lever is sloppy (loose) the lock nut is too loose.

5. Insert the inlet valve holding tool into the balance hole on the inlet tube. Push forward on the tool to stop the inlet valve stem from turning. Adjust the nut until the free flow stops and there is $\frac{1}{16}$ " (1.5 mm) to $\frac{1}{8}$ " (3.0 mm) of free play at the end of the lever.

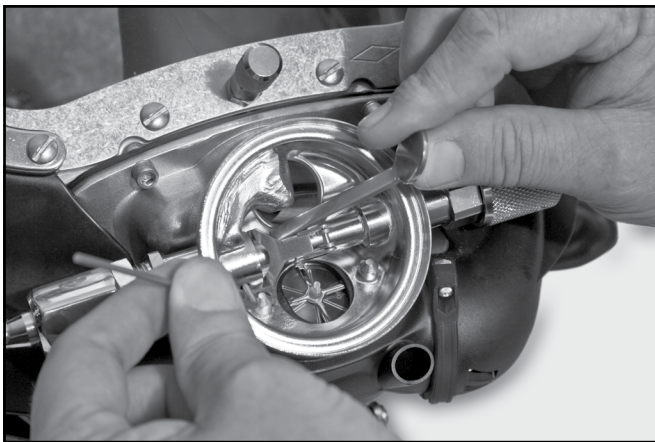

Insert the inlet valve holding tool into the balance hole on the inlet tube.

6. Remove the inlet valve holder tool.

7. Put the diaphragm and cover in place, depressing the cover tightly to simulate a properly tightened clamp.



Push down on the regulator cover to simulate a tightened clamp.

8. Depress the purge button in the center of the cover.



NOTE

(Reference, instructions following) Before bending the lever, double check the adjustments. The lever rarely requires bending. Usually levers require bending only when improperly serviced, or if damaged during disassembly

9. There must be $\frac{1}{16}$ " (1.5 mm) to $\frac{1}{8}$ " (3.0 mm) of free travel before the purge button actuates, resulting in a slight flow of gas. If a slight flow of gas develops with the purge button depressed less than $\frac{1}{16}$ " (1.5 mm), the lever will require bending down.

If the purge button travels further than a $\frac{1}{8}$ " (3.0 mm) before gas flow starts, the lever will require bending upward.

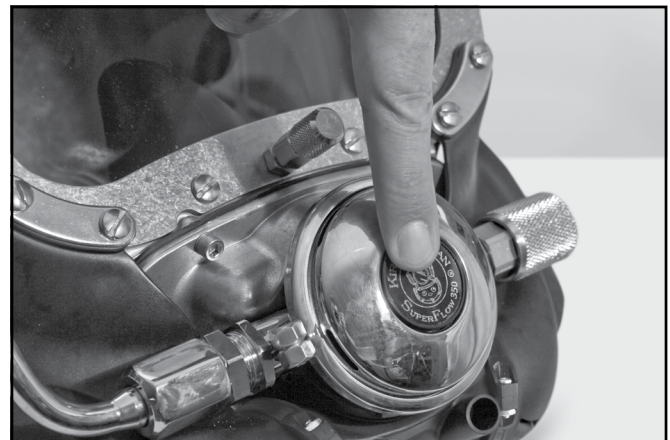

Test the response of the purge button.

10. To bend the lever up, remove the lever and carefully place it in a vice. Grip the lever from the side with a pair of long nosed pliers and bend the roller end up with your finger. Bend it only a small amount at a time.



NOTE

Be very careful to not place undue stress on the lower legs of the lever as this will disfigure the feet and cause spongy operation.

11. To bend the lever down, place the disk end of the KMDSI 1/4" wrench onto the flat area of the adjustment tube within the regulator, sliding the disk as far as possible under the lever. With your finger, slightly bend the lever down over the disk to the desired height. Be careful not to bend the lever too far! Bend it slightly then check it.

CAUTION

The legs of the lever must be properly aligned in the same plane. If one leg is up and the other is down, the regulator will not perform properly.

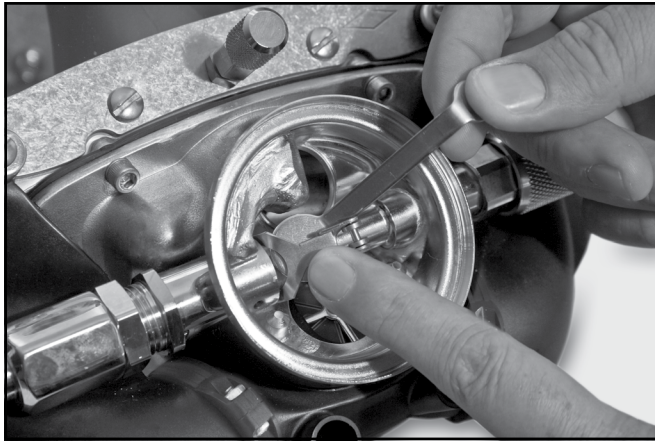

Use the disk end of the KMDSI wrench to bend the lever down.

12. Replace the diaphragm and the cover. Test the purge button. Continue until proper tolerances are reached.

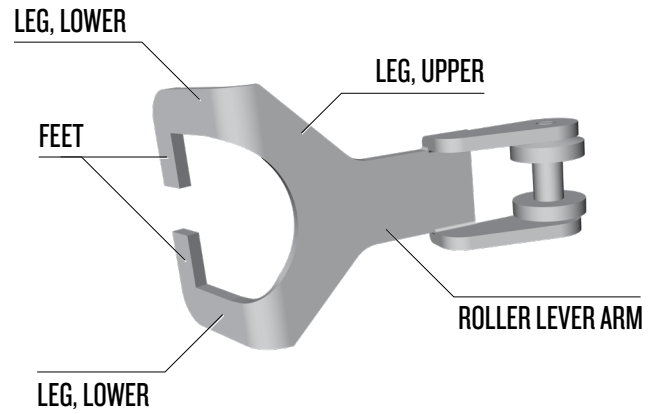

Note that the legs of the roller lever must be properly aligned and in the same plane for the lever to work correctly.

1.7.2 SuperFlow® 350 Regulator Steady Flows When Pressured Up: Special Tools Used (No P/N 525-620 KMDSI Tool Kit)

Tools required:

- Small Flat Blade Screwdriver.
- Small Jewelers Screwdriver or Metal Scribe.
- Needle Nose Pliers.

If using KMDSI regulator tool kit, see "1.7.1 Tuning the SuperFlow® 350 Regulator" on page SF350-19

The demand regulator is rugged and reliable. However, to maintain optimum performance it should be checked prior to each diving day in accordance with the brief procedure **Demand Regulator Test for Correct Adjustment, Fully Assembled.**

If adjustment is necessary after completing the demand regulator test "1.2.4 SuperFlow® 350 Demand Regulator Bias Adjustment Servicing, Demand Regulator on the Helmet" on page SF350-5, and the KMDSI P/N 525-620 tool kit is not available, proceed as follows:

1. Remove the regulator clamp, cover and diaphragm.
2. Adjust the regulator adjustment knob all the way in. Finger tight only.
3. Pressurize the regulator to between 120-150 p.s.i.g. (8.5-10 bar).
4. If the regulator is not free flowing, slowly back out on the adjustment knob until a slight free

flow is heard and then rotate the adjustment knob in (clockwise) $\frac{1}{4}$ turn and depress the purge button momentarily. Repeat this procedure until the gas flow stops.

Usually at this point the regulator adjustment knob will be between 5 and 7 turns out.



If when backing the adjustment knob out from the full “in” position, the regulator starts free flowing at less than five turns, then this usually indicates insufficient free play at the lever.

There are several issues that could cause the regulator to free flow, even when the adjustment knob is turned all the way in. These are as follows:

- A) ***The regulator was rebuilt and the lock nut is too tight. If this is the case, the nut must be loosened.***
- B) ***The washer was never removed from the regulator and a second one has accidentally been installed. If this is the case, the second washer must be removed.***
- C) ***The regulator body has never been properly serviced and there is corrosion inside the body, making proper inlet valve travel impossible.***

5. Check the free play at the lever. The lever should have between $\frac{1}{16}$ – $\frac{1}{8}$ " (1.5–3.0 mm) play. If adjustment is necessary, adjust using the alternate tools previously listed.

⚠ WARNING

The lock nut must not be loosened more than $\frac{1}{8}$ turn to lower the height of the lever. If more adjustment is necessary the lever should be bent downward. If the lock nut is loosened more than $\frac{1}{8}$ turn the lever will not have enough travel for proper flow rates.

⚠ WARNING

The lock nut must always be replaced if removed from the inlet valve. The plastic material that locks the nut is not designed for multiple reuse. If the nut comes loose during a dive the regulator would free flow heavily. In the situation where the diver is using bottled breathing gas this would result in a rapid consumption of breathing gas.

Alternate method: If a KMDSI P/N 525-620 tool kit is not available, a small jeweler’s screwdriver or metal scribe can be inserted in the slot on the end of the inlet valve to keep it from rotating, and needle nose pliers may be used to rotate the lock nut. While holding the slot of the inlet valve to prevent rotation, carefully rotate the nut “In” (clockwise to remove lever play and “Out” (counterclockwise) to increase lever play.

Only turn the adjustment nut $\frac{1}{8}$ turn at a time. Depress the lever momentarily after each adjustment and observe the lever play. It may be necessary to complete this procedure several times, as the procedure requires estimating the proper position of the nut. If the regulator free flow does not stop after this procedure, refer to regulator disassembly and cleaning sections of this manual.

6. When adjustment is complete, place the diaphragm and cover in place, and press tightly down on the cover to simulate the action of the clamp.



Press the cover over the diaphragm.

**NOTE**

(Reference, instructions following) Before bending the lever, double check the adjustments. The lever rarely requires bending. Usually levers require bending only when improperly serviced, or if damaged during disassembly.

7. With the cover pressed tight against the diaphragm, if the regulator starts to free flow, the lever may need to be bent down slightly. If the regulator does not free flow, slowly depress the purge button until a slight free flow develops. The purge button should depress no further than $\frac{1}{8}$ " (3.0 mm) before the regulator develops a flow.

If the regulator does not develop a slight free flow when the purge button is depressed in $\frac{1}{8}$ " (3.0 mm), then the lever will require slight upward bending.

8. Install the clamp and clamp screw. Tighten the screw to the correct torque. See "Torque Specs" module.

9. Again, press on the purge button in the cover. It must have $\frac{1}{16}$ " (1.5 mm) minimum and $\frac{1}{8}$ " (3.0 mm) maximum free travel before it contacts the diaphragm. If there is more than $\frac{1}{8}$ " (3.0 mm) travel, the lever must be bent upward, per "1.7.1 Tuning the SuperFlow® 350 Regulator" on page SF350-19. If the button has only slight or no free travel, the lever must be bent down.

⚠ WARNING

The lock nut must not be loosened more than $\frac{1}{8}$ turn to lower the height of the lever. If more adjustment is necessary the lever should be bent downward. If the lock nut is loosened more than $\frac{1}{8}$ turn the lever will not have enough travel for proper flow rates.

10. If the purge button travel is correct, the adjustment is complete.

1.7.3 SuperFlow® 350 Regulator Exhaust Valve Replacement

Before removing the regulator exhaust valve, carefully inspect the area around the edges to ensure the rubber exhaust valve is in contact with the regulator body. The metal cross area of the body under the valve may be slightly bent outward resulting in the valve not sealing.

If the exhaust valve is high and not sealing, lightly press in on the metal cross, bending the metal in

slightly until the rubber valve seats. Remove the existing regulator exhaust valve by pulling it out of its mount hole. If the valve tears, make sure that it is removed without any valve material left inside the regulator.

**NOTE**

Before installing the new exhaust valve, ensure the spokes holding the valve are smooth, even and not bent. The exhaust valve seating area should be free of dirt and corrosion to ensure the valve can lay flat and seal properly. **NEVER lubricate the valve.**

1. Remove the regulator clamp screw and clamp.
2. Remove the regulator cover and the diaphragm.
3. Install the new regulator exhaust valve by placing the stem of the valve in through the hole in the hub of the spokes from the outside of the regulator. Gently, (using needle nose pliers) from the inside of the regulator, pull the stem of the valve through the hole in the hub of the spokes until it pops into its seating area.

⚠ WARNING

The exhaust valve must be correctly installed into the valve seat or it will not seal correctly. This could lead to a backflow of water into the helmet, which could expose the diver to contaminants in the water. Depending upon the properties of the contaminants, this could lead to serious personal injury or death.

⚠ WARNING

The exhaust valve must be installed in the correct orientation into the regulator body. If the valve is installed backwards, the diver will be unable to exhale. This could lead to suffocation and death.

4. Reinstall the diaphragm, regulator cover, clamp and clamp screw.